

USER MANUAL

CALYPSO IOT DESIGN KIT FOR
MICROSOFT AZURE

2610059035001

VERSION 1.1

OCTOBER 18, 2024

WÜRTH ELEKTRONIK MORE THAN YOU EXPECT

MUST READ

Check for firmware updates

Before using the product, make sure you use the most recent firmware version, data sheet, and user manual. This is especially important for Wireless Connectivity products that were not purchased directly from Würth Elektronik eiSos. A firmware update on these respective products may be required.

We strongly recommend including the possibility of a firmware update in the customer system design.

Revision history

Manual version	Notes	Date
1.0	Initial version	June 2023
1.1	<ul style="list-style-type: none">• Fixed broken links.• Added chapter 7.	October 2024

Abbreviations

Abbreviation	Name	Description
API	Application programming interface	A way for two computer programs to communicate with each other.
DPS	Device provisioning service	A service of Microsoft Azure
HTTP(S)	Hyper Text Transfer Protocol	An application layer protocol
IoT	Internet of Things	
Li-Po	Lithium polymer	A type of rechargeable Battery
MQTT	Message Queuing Telemetry Transport	A light weight messaging protocol for TCP/IP based network
(a)PaaS	(application) Platform as a Service	A category of cloud computing services.
REST	Representational state transfer	A software architecture style.
SNTP	Simple Network Time Protocol	A Protocol to synchronize time on the network
UI	User Interface	The user interface is the space where interactions between humans and machines occur
UX	User experience	The user experience (UX) is how a user interacts with and experiences a product, system or service

Contents

1	General description	4
1.1	Introduction	4
1.2	Block diagram	5
1.3	Contents	5
2	Functional description	6
2.1	Parts of an IoT application	6
2.2	Remote Monitoring and Control using the design kit	8
2.2.1	System architecture	8
2.2.2	System design using the design kit	9
2.3	Constituents of the IoT design kit	10
2.3.1	WE sensors FeatherWing	10
2.3.2	WE Calypso WiFi FeatherWing	11
2.3.3	Adafruit Feather M0 Express	12
2.3.4	Adafruit FeatherWing OLED	12
2.3.5	Microsoft Azure IoT central platform	13
3	Quick start guide	15
3.1	Prerequisites	15
3.2	Create an IoT central application	16
3.3	Create certificates and the device configuration file	19
3.4	Upload the Root certificate to IoT central	23
3.5	Configure the device	25
3.6	View the device default dashboard	30
3.7	Send commands to device	31
3.8	Update device property	32
3.9	Factory reset	33
4	Software description	34
4.1	Software architecture	34
5	Regulatory compliance information	36
5.1	Exemption clause	36
6	Important notes	37
7	Terms of Use for Würth Elektronik eiSos GmbH & Co. KG EV-Boards, evaluation kits and evaluation modules	37
8	Legal notice	39
9	License terms	40

1 General description

1.1 Introduction

The Würth Elektronik eiSos's Calypso IoT design kit is an EV-Board set with pre-installed firmware that enables easy creation and evaluation of a secure end-to-end IoT solution using Microsoft's Azure IoT central.

Azure IoT Central is a ready-made UX and API surface for connecting and managing devices at scale, delivering reliable data for business insights. It pre-assembles platform as a service (PaaS) offerings, bringing together each service beneath it for an easy-to-configure, comprehensive, and secure IoT offering.

This design kit offers a reliable hardware platform for rapid prototyping using FeatherWings. The Würth Elektronik eiSos's FeatherWing development boards are open source and fully compatible with the Feather form factor from Adafruit. Through these development boards, Würth Elektronik brings a range of wireless connectivity modules, sensors, and power modules to the Feather ecosystem.

This hardware platform with pre-installed open-source reference firmware and Microsoft's IoT central cloud platform supercharges prototyping of any IoT solution.

This document gives a detailed description of the steps involved in creating an IoT solution using the hardware in the design kit and the IoT central platform.

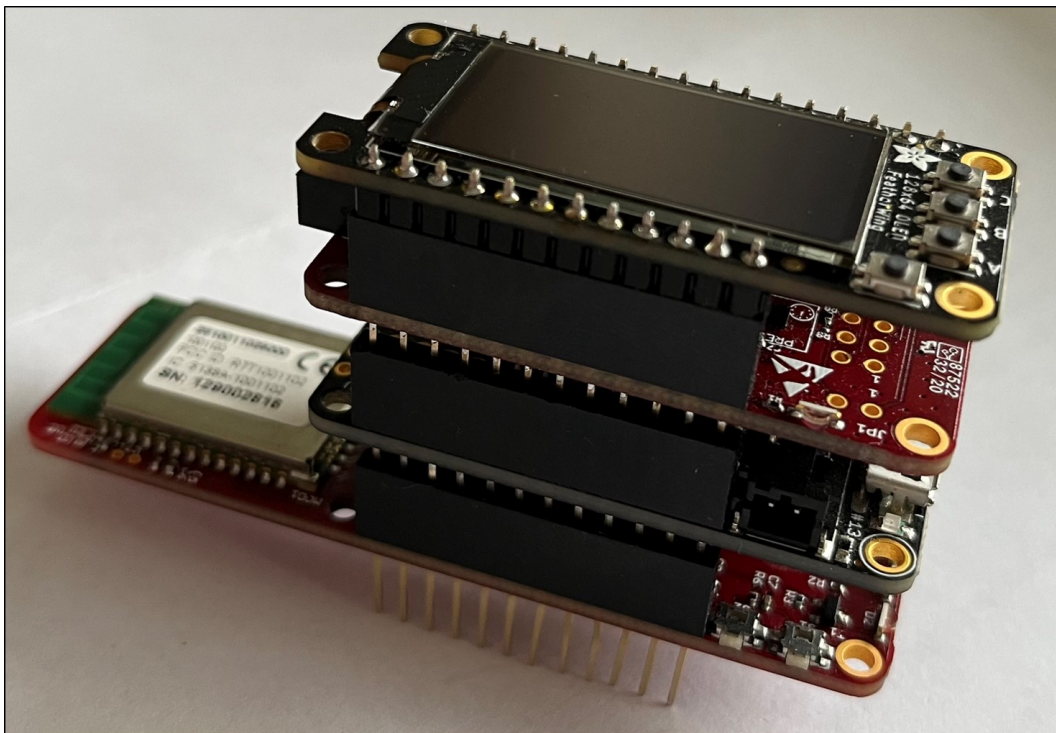

Figure 1: Calypso IoT design kit

1.2 Block diagram

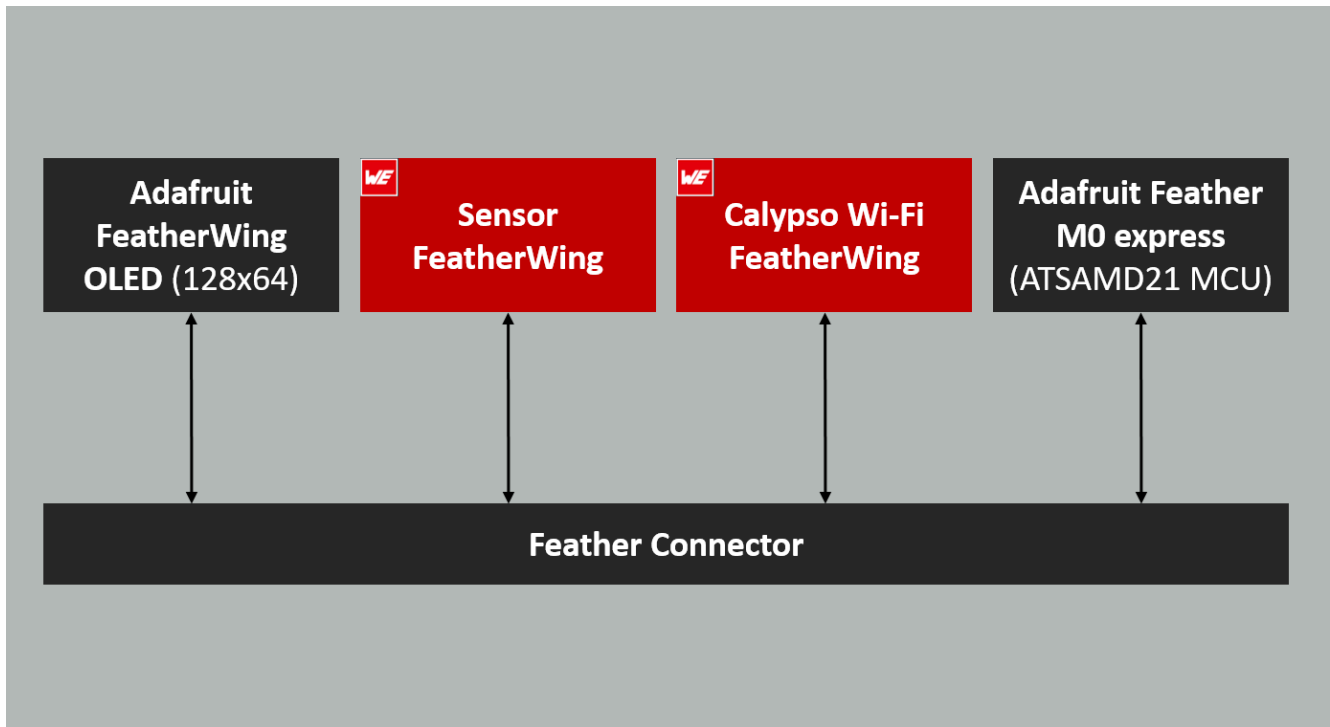

Figure 2: Block diagram - Calypso IoT design kit

1.3 Contents

Description	Quantity
Würth Elektronik Sensor FeatherWing	1
Würth Elektronik Calypso WiFi FeatherWing	1
Adafruit FeatherWing OLED	1
Adafruit Feather M0 pre-flashed with firmware from Würth Elektronik	1
Packaging: ESD safe bag	1

Table 1: Contents of the design kit (2610059035001)

2 Functional description

The Calypso IoT design kit was created to simplify the development of an IoT application. The Internet of Things (IoT) can be broadly defined as an umbrella term for a range of technologies that enable devices to connect and interact with each other. Interconnected devices generating data provide for a range of new applications. Industrial automation, healthcare, smart home, smart cities, smart grids, and smart farming are some of the areas in which IoT provides substantial benefits.

Dubbed the "fourth industrial revolution" or Industry 4.0, the Industrial IoT (IIoT) is the digitization of industrial assets and processes that connects products, machines, services, and locations/sites to workers, managers, suppliers, and partners. Closer networking of the digital world with the physical world of machines helps achieve higher productivity, safety, efficiency, and sustainability.

This chapter begins by describing the parts of a typical IoT application. Further, all the components of the design kit are described in detail. Finally, a step-by-step guide for creating a sensor-to-cloud IoT solution prototype using tools from Würth Elektronik eiSos and the IoT central platform from Microsoft is presented in the following chapters.

2.1 Parts of an IoT application

Irrespective of the area of application, an end-to-end IoT solution consists of the following components (figure 3).

- **Sensors and actuators:** This is a part of the system that directly interfaces with the physical environment. Sensors measure the state of the environment and interpret the same as analog or digital data. On the other hand, actuators activate a physical change in the measured environment. Advances in the field of electronics in general and semiconductors, in particular, have led to the availability of a wide range of sensors and actuators which are highly efficient and yet very compact.
- **Wireless connectivity:** Sensors and actuators are typically installed in devices with limited access to the digital world. Consider, for example, a temperature sensor mounted inside an industrial boiler. Wireless connectivity provides in addition to many advantages the reachability necessary for such applications. A wide variety of standards as well as proprietary wireless connectivity solutions are available today. A number of factors including range, throughput, spectrum regulations, local statutory requirements, and power budget determine the choice of wireless connectivity solution.

Modern embedded designs usually combine the above components into a single device (sensor node) interacting with a gateway.

- **Gateway device:** A gateway device acts as a bridge between the physical and the digital worlds. It interprets the multitude of wireless connectivity protocols, collects the data, and forwards the same in a format understood by the entities above. In certain applications, the gateway device also performs basic analytics like threshold detection.

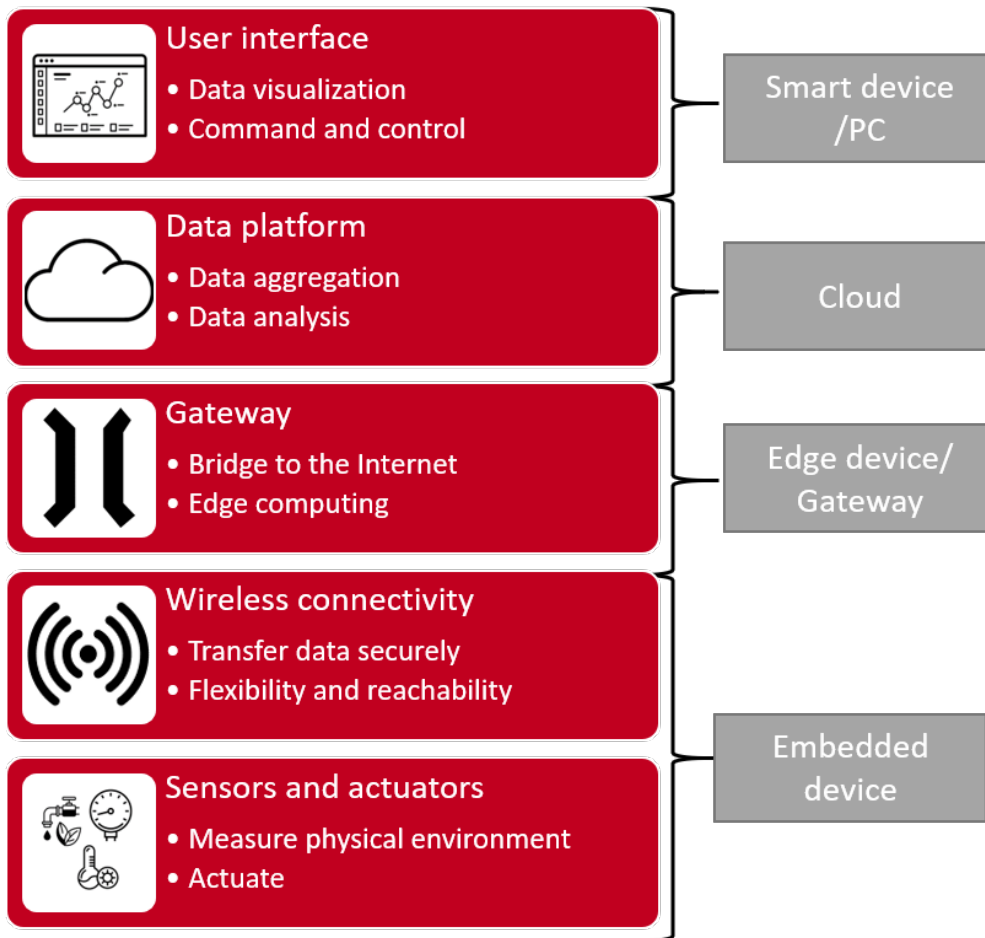

Figure 3: IoT application stack

- Data platform:** This is the platform where the data is finally stored and presented for further analysis. Options here can range from a local database to a cloud server with redundancies. A typical platform consists of the components as shown in figure 4. The data platform enables the use of technologies like Artificial Intelligence (AI) and Machine Learning (ML) to perform advanced data analytics that generates value additions to the application.

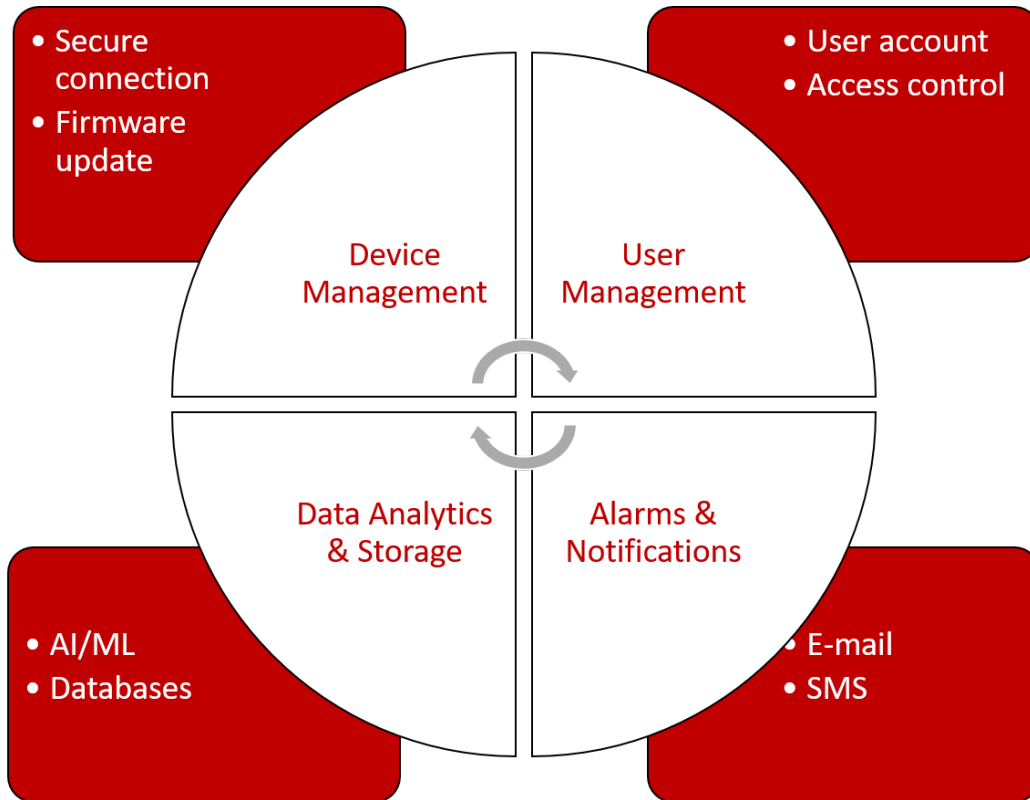

Figure 4: Components of a data platform

- **User interface:** This is the interface between human users and the digital world. Here the status of the observed environment is presented in a human-readable format. The user can take the necessary actions by interacting with this application

2.2 Remote Monitoring and Control using the design kit

The IoT creates a universe of sensors that enables accelerated deep learning of existing operations that allows rapid contextualization, automatic pattern, and trend detection. This leads to true quantitative capture of qualitative operations resulting in better quality, efficiency, higher safety, lower costs, and several other benefits. This has led to the use of IoT in several application use cases.

Remote monitoring and control of the operational environment (temperature, humidity, pressure, etc.) is one of the essential tasks in the industry. Maintaining optimal conditions and automating this process have been a challenge. This use case is considered out-of-the-box for this design kit presented here.

2.2.1 System architecture

The above-mentioned task requires sensors/actuators to interact with the environment, a wireless connectivity method, to collect the data, a cloud platform to store data, and a user interface to enable human interaction. The architecture of such a system is as shown in figure 5.

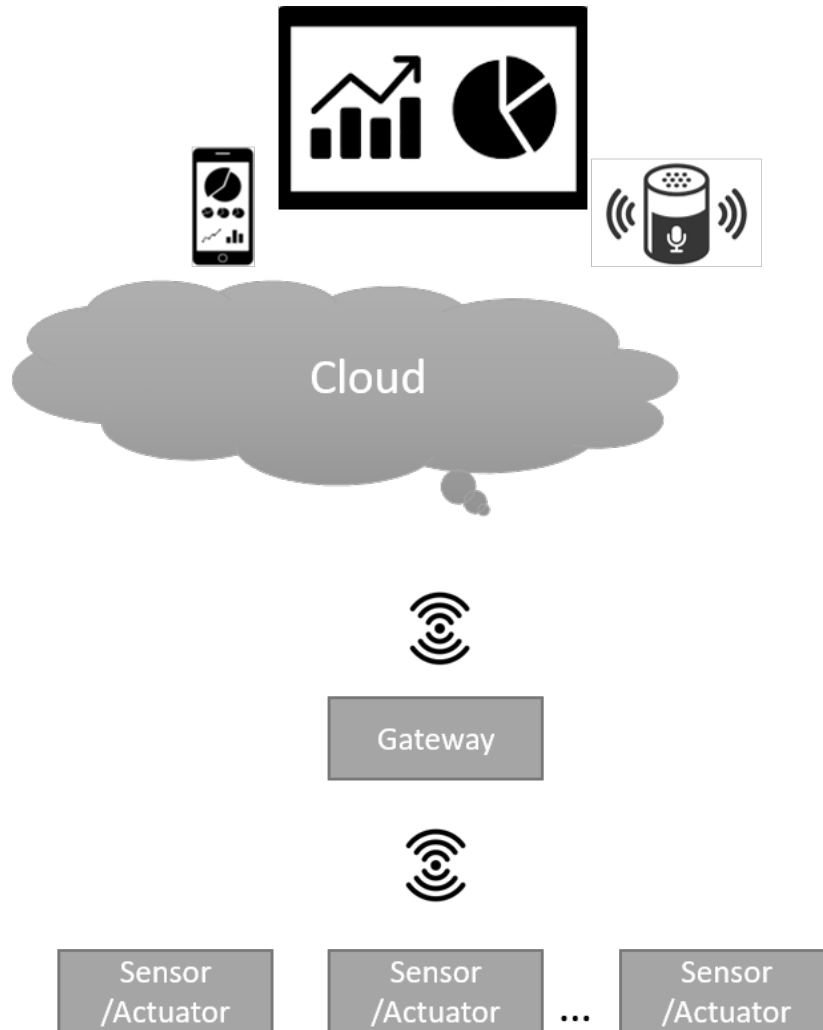

Figure 5: System architecture

2.2.2 System design using the design kit

Figure 6 illustrates the design that realizes the architecture described in chapter 2.2.1. The sensor values of the WE Sensors FeatherWing are read by the Feather M0 express MCU and transferred to the IoT central cloud platform over WiFi where it is stored, visualized, and processed. The data is also displayed locally on the OLED. It is also possible to set parameters like sensor read frequency and trigger operations like changing the LED colour from the cloud. Hence, performing remote monitoring as well as control from the cloud.

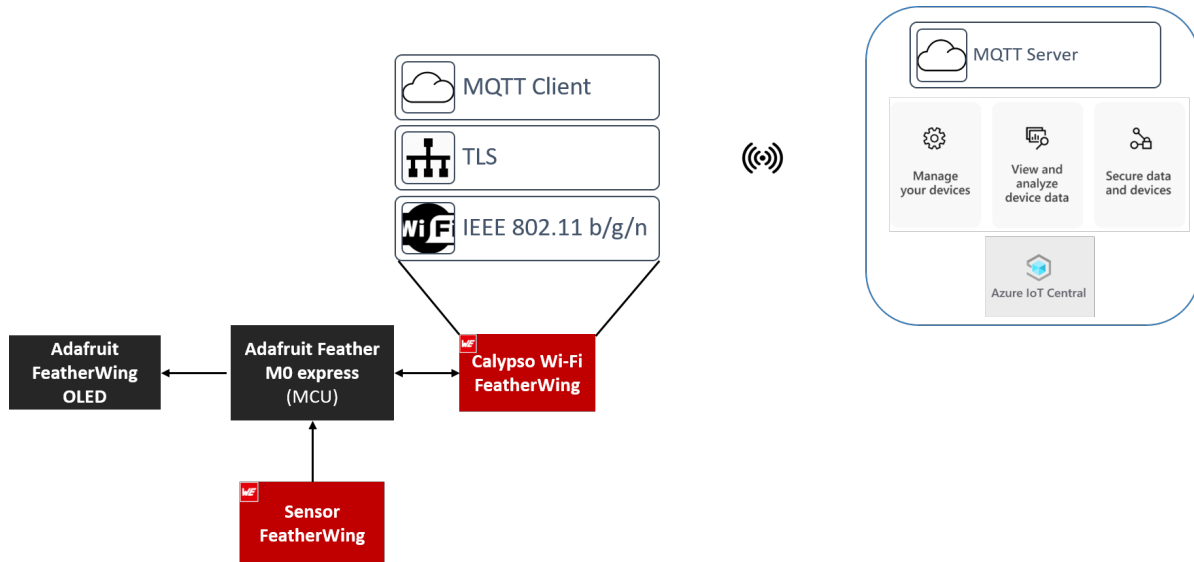

Figure 6: System design

2.3 Constituents of the IoT design kit

In this section, all the constituents of this design kit are described.

2.3.1 WE sensors FeatherWing

The Würth Elektronik eiSos *Sensor FeatherWing* is a sensor development board fully compatible with the popular Adafruit Feather line of development boards. It consists of the following four sensors,

- WSEN-PADS - Absolute pressure sensor (2511020213301)
- WSEN-ITDS - 3-axis acceleration sensor (2533020201601)
- WSEN-TIDS - Temperature sensor (2521020222501)
- WSEN-HIDS - Humidity sensor (2523020210001)

All four sensors are connected over the shared I²C bus and hence can be connected to any of the Feather microcontroller boards. The Arduino (C/C++) drivers and examples are made available under the following link, <https://github.com/WurthElektronik/FeatherWings> makes it easy to build a prototype to kick-start the application development. This development kit comes pre-flashed with code that reads the sensor data and forwards the same to the cloud platform.

The Sensor FeatherWing also has the 4-pin JST QWIIC[®] connector on-board. SparkFun's QWIIC[®] Qwiic Connect System uses 4-pin JST connectors to quickly interface development boards with sensors, LCDs, relays and more. Additionally, a 6-pin connector enables the extension of the FeatherWing with several EV-Boards from Würth Elektronik eiSos.

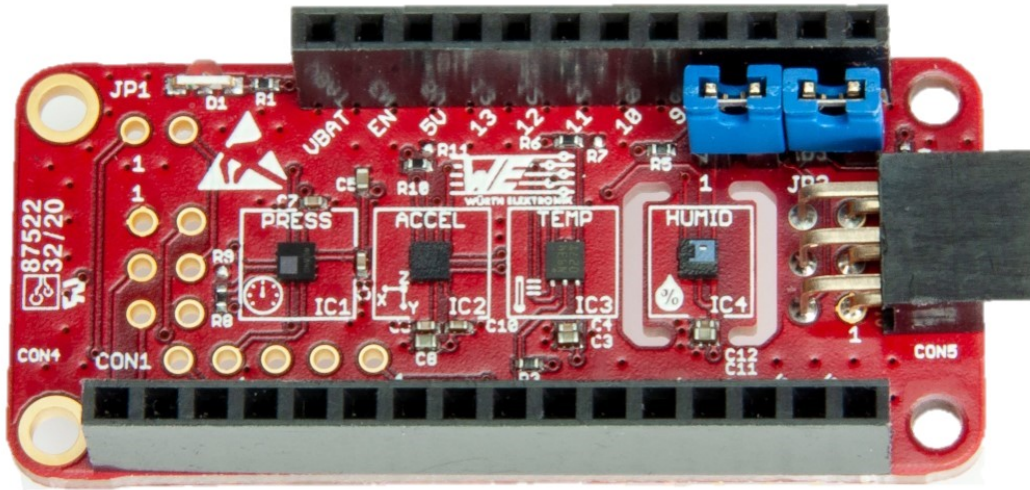

Figure 7: The WE Sensor FeatherWing (2501000201291)

2.3.2 WE Calypso WiFi FeatherWing

The Würth Elektronik eiSos *Calypso WiFi FeatherWing* is a development board that offers a secure 2.4 GHz WiFi connectivity solution. It is fully compatible with the popular Adafruit Feather line of development boards and extends the Feathers with WiFi connectivity.

The Calypso IoT design kit consists of the Calypso radio module that offers WiFi connectivity based on IEEE 802.11 b/g/n with a fully featured TCP/IP (IPv4 and IPv6) stack. With out-of-the-box support for commonly used network applications like SNMP, HTTP(S), and MQTT(S), Calypso offers an easy and secure solution to any IoT application.

It has an AT-style command interface on the standard UART and hence can be connected to any of the Feather microcontroller boards. The Arduino (C/C++) drivers and examples made available the following link, <https://github.com/WurthElektronik/FeatherWings> make it easy to build a prototype to kick-start the application development. This development kit comes pre-flashed with code that reads the sensor data and forwards the same to the cloud platform.

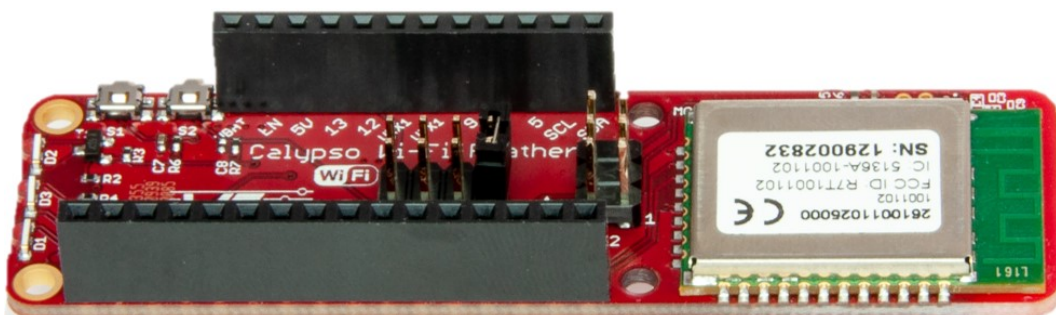

Figure 8: The WE Calypso FeatherWing (2610039025001)

2.3.3 Adafruit Feather M0 Express

The *Adafruit Feather M0 express* is built around the ATSAM21G18 ARM Cortex M0+ processor, clocked at 48 MHz and at 3.3 V logic, the same one used in the new Arduino Zero. This chip has 256K of FLASH and 32K of RAM and comes with built-in USB so that it has USB-to-Serial program and debug capability built in with no need for an FTDI-like chip. It comes with a Mini NeoPixel, 2 MB SPI Flash storage, and can be powered using a Li-Po battery.

The MCU on this board is pre-flashed with firmware that configures the sensors and the wireless module. It performs all the necessary steps to provision and connect to the IoT central platform. Once the connection is established, the sensor data is read periodically and sent to the cloud.

The code for this firmware can be found under the following link,
<https://github.com/WurthElektronik/Calypso-IoT-PnP-Design-Kit>

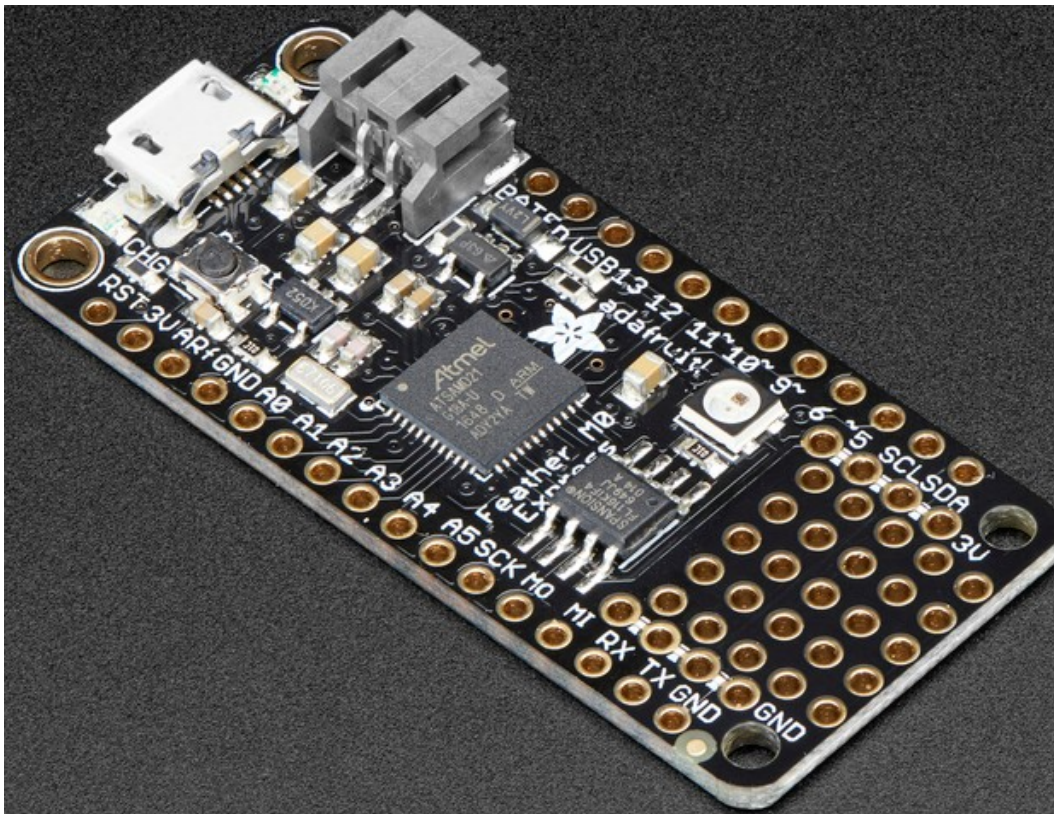

Figure 9: The Adafruit Feather M0 express

2.3.4 Adafruit FeatherWing OLED

The *Adafruit FeatherWing OLED* is a 128X64 pixel monochrome OLED display in the feather form factor. Using the Feather pin header, this board adds a display and three user buttons to any Feather main board.

These displays are small, only about 1.3" diagonal, but very readable due to the high contrast of an OLED display. This screen is made of 128x64 individual white OLED pixels and because

the display makes its own light, no backlight is required. This reduces the power required to run the OLED and is why the display has such high contrast. The three mini tactile buttons as well as the reset button along with the display add a miniature user interface to the Feather.

The OLED uses only the two I²C pins on the Feather, and you can pretty much stack it with any other FeatherWing, even ones that use I²C since that is a shared bus.

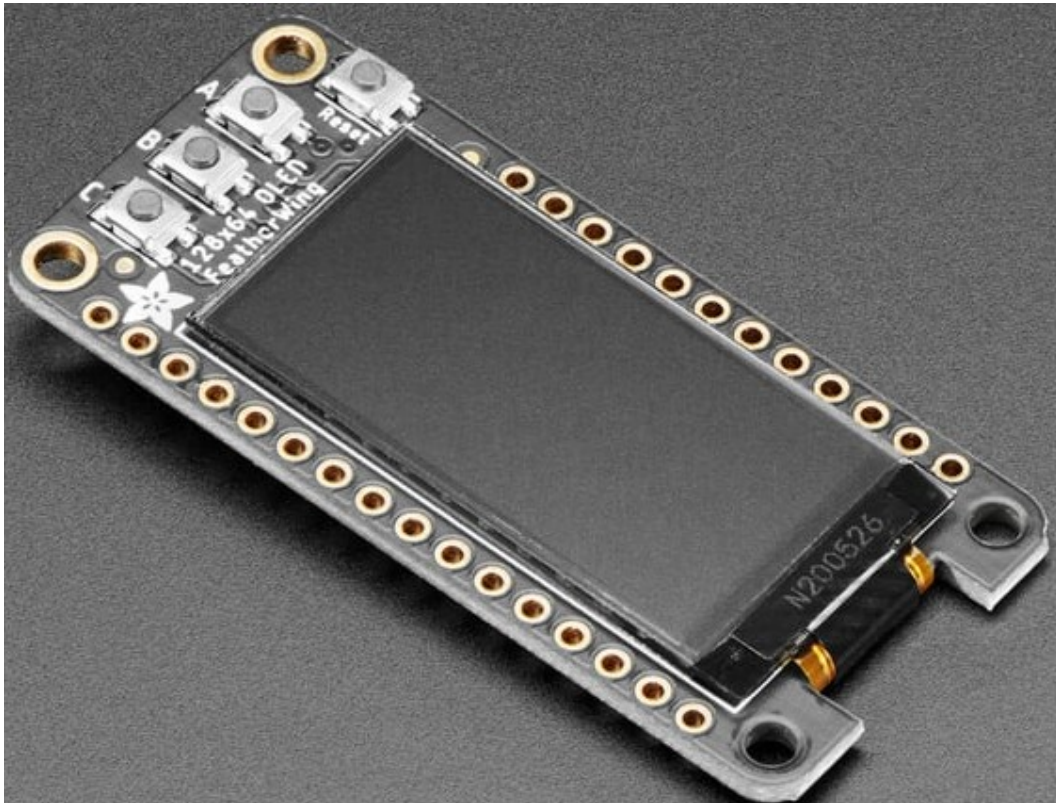

Figure 10: Adafruit FeatherWing OLED

2.3.5 Microsoft Azure IoT central platform

IoT Central is an IoT application platform as a service (aPaaS), developed by Microsoft that reduces the burden and cost of developing, managing, and maintaining enterprise-grade IoT solutions. Choosing to build with IoT Central allows the opportunity to focus time, money, and energy on transforming the business with IoT data, rather than just maintaining and updating a complex and continually evolving IoT infrastructure.

The web UI lets quick connection of devices, monitoring of device conditions, creating rules, and managing millions of devices and their data throughout their life cycle. Furthermore, it enables acting on device insights by extending IoT intelligence into line-of-business applications.

IoT Central is a ready-made environment for IoT solution development. It's an application platform as a service (aPaaS) IoT solution and its primary interface is a web UI. There is also a REST API that lets interaction with the application programmatically.

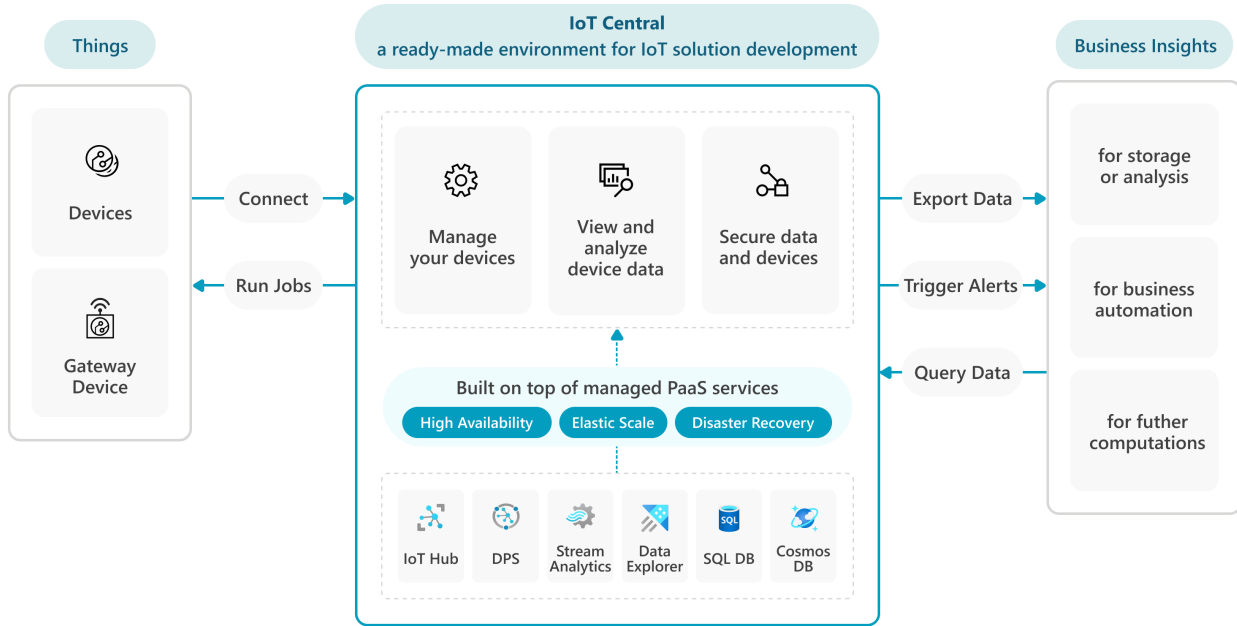

Figure 11: Architecture of IoT central platform.

Source: <https://learn.microsoft.com/en-us/azure/iot-central/core/concepts-architecture>

More information about the IoT central platform can be found under the link, <https://learn.microsoft.com/en-us/azure/iot-central/>.

3 Quick start guide

The Calypso IoT design kit comes pre-flashed and ready-to-use out-of-the-box. This chapter describes the steps to get the kit up and running in a few minutes.

3.1 Prerequisites

The following items are necessary to go through this process.

- The design kit with M0 Feather stacked with Calypso WiFi FeatherWing, the Sensor Featherwing, and the OLED FeatherWing.

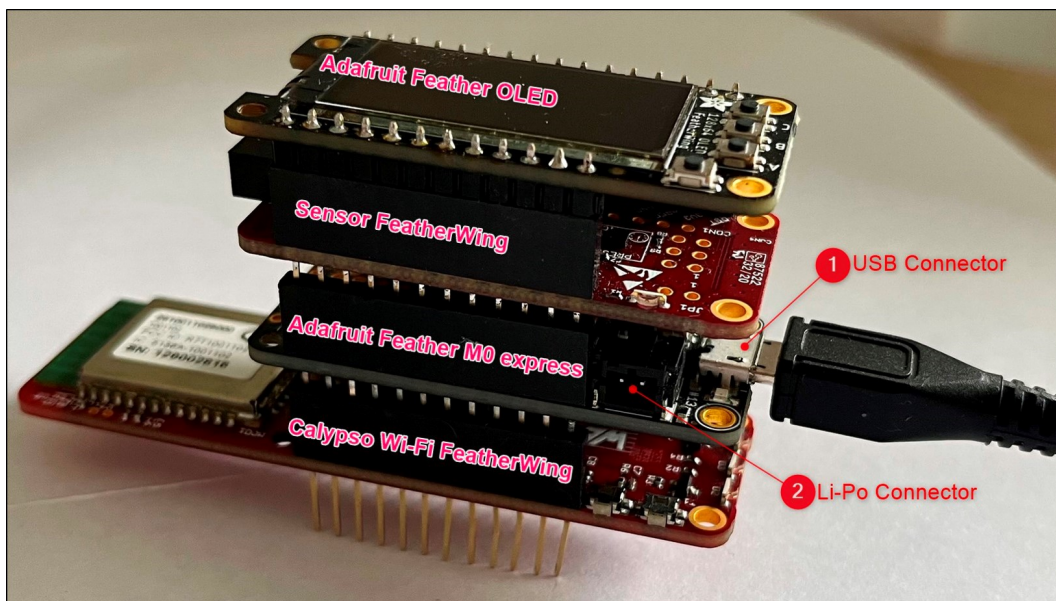

Figure 12: The design kit

- A Micro-USB cable to power up the design kit stack.
- A WiFi access point (IEEE 802.11 b/g/n compatible) with internet access.
- WiFi enabled computer with a browser (Chrome or edge recommended).
- A Microsoft Azure account. This can be created under the following link, <https://azure.microsoft.com/en-us/free/>



A valid credit card is required for creating an Azure subscription. The free tier can be used to run through this example without any charges on the credit card.

- The WE certificate generator tool. This can be downloaded from, <https://www.we-online.com/certificategenerator>



This tool works only on Windows platform



The design kit will always be delivered with the latest Firmware version (> v2.2.0). In case you use a Calypso FeatherWing which you received separately, make sure that the Calypso FeatherWing has a Firmware version > v2.2.0.

3.2 Create an IoT central application

- Sign in to the Azure portal, <https://portal.azure.com/> If a subscription does not exist, please create a subscription as described in this [link](#).
- From the Azure homepage, select the "+ Create a resource button" and then enter "IoT Central application" in the "Search service and marketplace" field.
- Select "IoT Central application" from the search results and then select "Create".

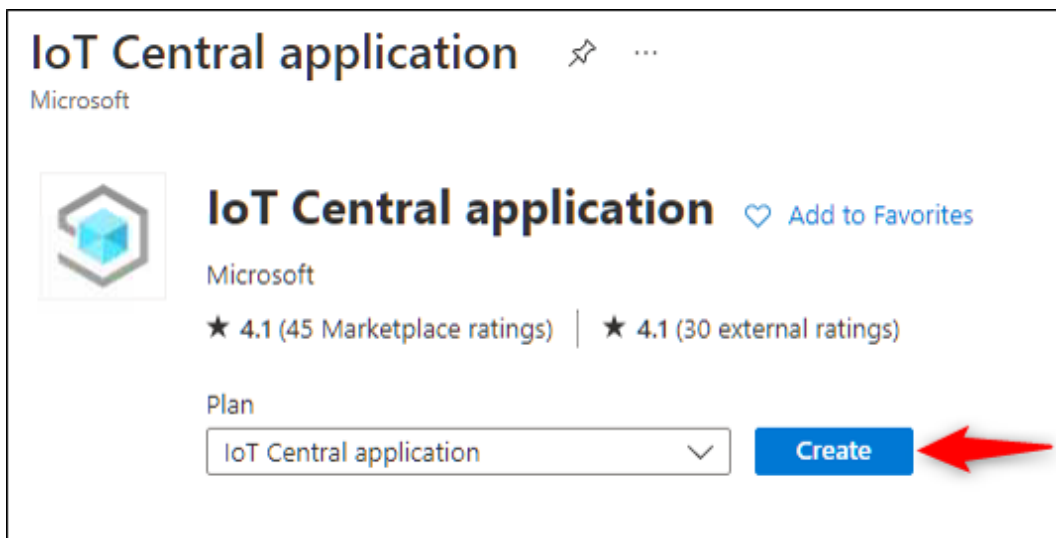

Figure 13: IoT central application

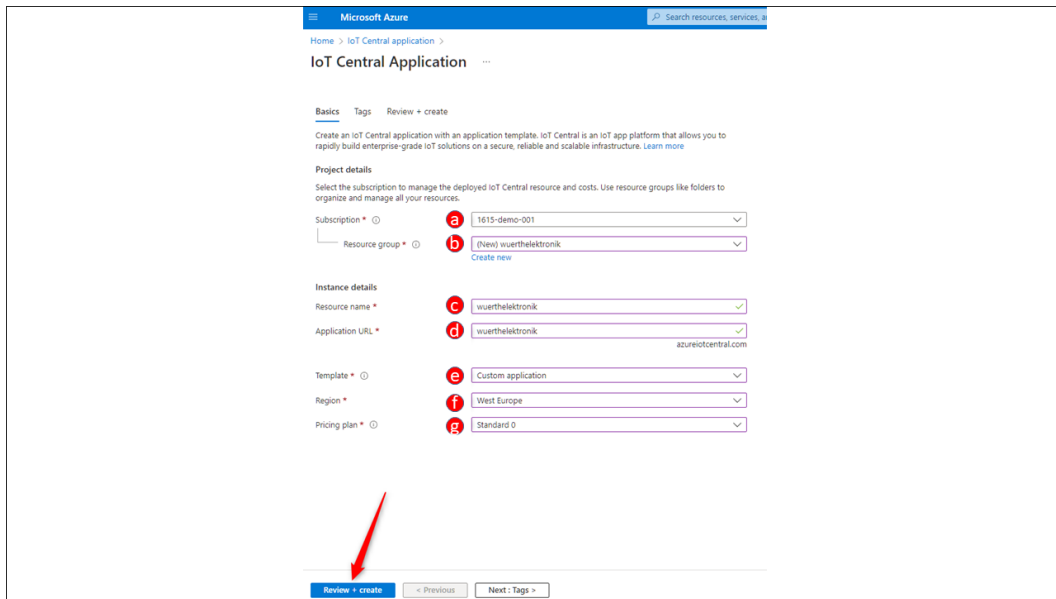

Figure 14: IoT central application parameters

- On the Basics tab, complete the fields as follows:
 1. **Subscription:** Select the subscription to use for the application.
 2. **Resource group:** Select a resource group or create a new one. To create a new one, select Create new and fill in the name you want to use. To use an existing resource group, select that resource group. For more information, see Manage Azure Resource Manager resource groups.
 3. **Resource name:** Type in a name for the IoT central application. For example, "wuerthelektronik".
 4. **Application URL:** This will be automatically set to <Resource name>.azureiotcentral.com. In this example "wuerthelektronik.azureiotcentral.com"
 5. **Template:** From the drop-down, select "Custom application".
 6. **Region:** Select the region in which the application will be located. Select a location that is geographically the closest. For example, West Europe.
 7. **Pricing Plan:** Choose the appropriate pricing tier. The standard tier 0 is good to start prototyping. More details on pricing can be found under, <https://azure.microsoft.com/en-us/pricing/details/iot-central/>
- Click on "Review + Create".
- In the following page, review the terms and click on "Create".
- Wait for the deployment to complete. After the process is complete, click on the "Go to resource" button to open the application.

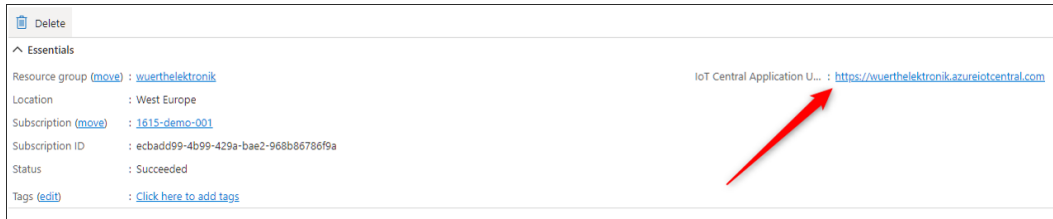

Figure 15: IoT central application URL

- Click on the IoT central application URL to open the newly created IoT central platform.

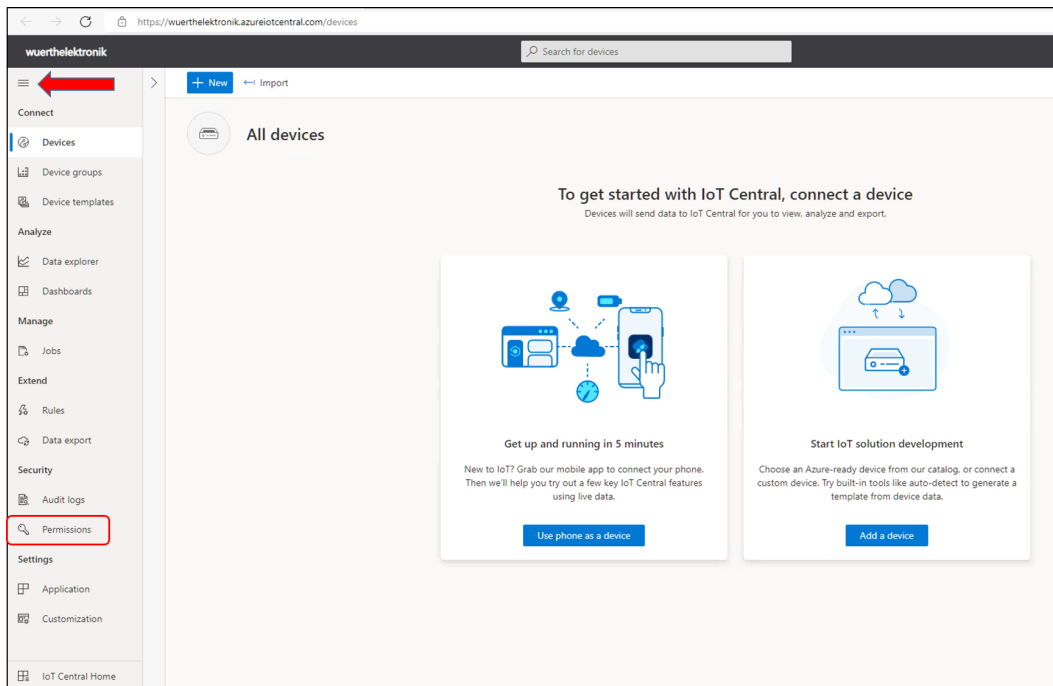

Figure 16: IoT central application homepage

- In the IoT central app open, "Permissions > Device connection groups" and note down the ID scope parameter for use in further steps.

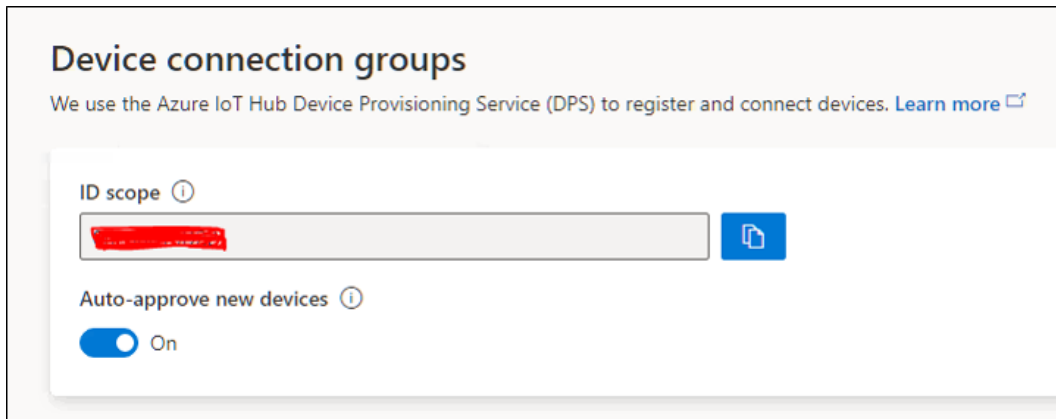

Figure 17: ID scope for the created IoT central application



For more information on creating an IoT central application, please refer to the following link <https://learn.microsoft.com/en-us/azure/iot-central/core/howto-create-iot-central-application>

3.3 Create certificates and the device configuration file

In order to securely connect the device to IoT central application, the device needs to implement a certain method for authentication. In this case, the X.509 certificate-based authentication is implemented. This method requires the creation of certificates for every device. In order to enable easy prototyping, Würth Elektronik eiSos's Certificate creation tool can be used. This tool creates all the certificates necessary to get started. Further, the device needs a configuration file that provides the parameters such as WiFi credentials. This PC tool also generates the device configuration file.



This tool is for evaluation purposes only. Do not use the certificates generated for deployment on end devices for security reasons.

- Download the WE certificate generator tool from <https://www.we-online.com/certificategenerator>
- Unzip to a suitable location on the computer and open the executable "WECertificate-Generator.exe"
- In order to configure the device and generate certificates, the following parameters are necessary,

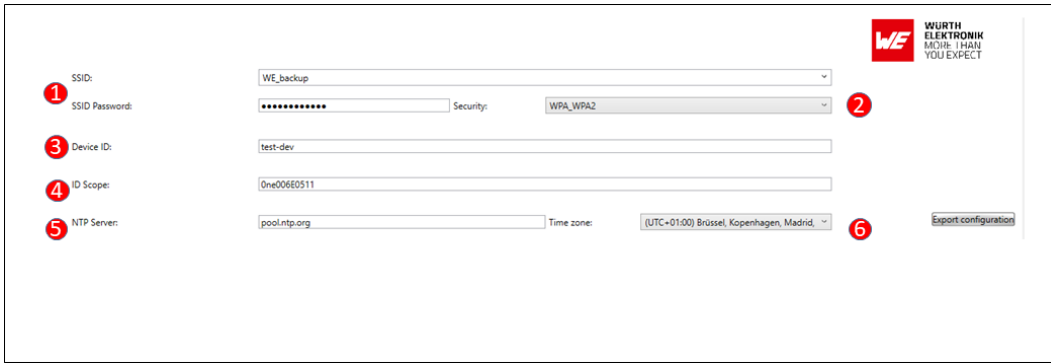

Figure 18: Parameters to configure the device

1. **SSID:** Select the WiFi connection to be used by the device from the drop-down menu. This is the name of the WiFi access point that the device needs to connect to the internet.
 2. **Password:** The password corresponds to the selected WiFi network.
 3. **Security:** Check if the correct security type is selected for the WiFi network.
 4. **Device ID:** This is the name of the device as it appears on the IoT central app. It should be unique per device. In this example, "test-dev" is used. Please use a device name of your choice.
 5. **ID scope:** Type in the ID scope noted in the previous section. ID scope is unique per application but common across devices.
 6. **NTP server:** If needed change the time server of choice that the module will use to get the current time.
 7. **Time zone:** Select the appropriate time zone.
- **Device root certificate:** This is the self-signed certificate that acts as the root of trust for all devices. The device root certificate is used to generate leaf certificates. Each device has a unique leaf certificate that identifies the device. The root certificate can be generated once and used for generating leaf certificates for several devices. The WE certificate uploader tool allows the creation on a new root certificate, saving the same and loading it back for subsequent usage.

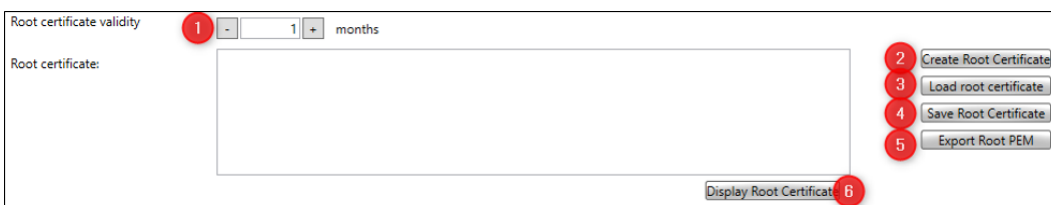

Figure 19: Device root certificate options

1. On first-time use set the validity time in months. For example, 1 month is chosen. The device will be securely connected for this period after which the device will be disconnected. The certificates need to be renewed for continuous operation.

2. Click on "Create root certificate" to create a new root certificate.
 3. **{Optional}** If a root certificate already exists, click on "Load root certificate". This opens a file browser. Browse to the correct location to choose the previously used root certificate. Use .pfx format certificate file.
 4. **{Optional}** Click on "Save root certificate" to save the generated root certificate for future use. This can be used to generate a file in .pfx format which can be reloaded for later use.
 5. **{Optional}** Click on "Export root PEM" to export the certificate in PEM format. This file needs to be uploaded to the IoT central application as will be explained in the subsequent sections.
 6. **{Optional}** Click on "Display root certificate" to view the certificate in the standard Windows format.
- **Device certificate:** Every device requires a unique device certificate to securely connect to the IoT central application. Each device certificate generated is exclusively linked to the device through the device ID and cannot be used on any other device.

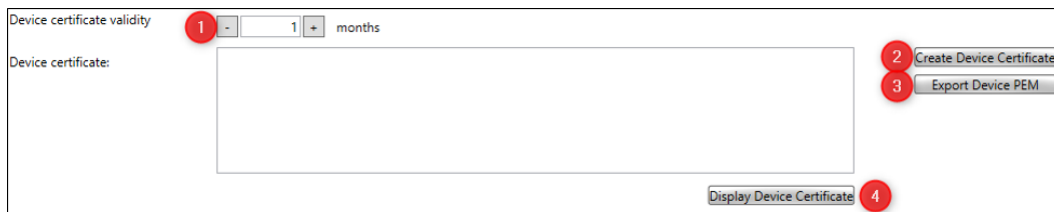

Figure 20: Device certificate options

1. For every device ID, set the validity time in months. For example, 1 month is selected. The device will be securely connected for this period after which the device will be disconnected. The certificates need to be renewed for continuous operation. The validity period of the device certificate cannot be longer than the validity of the root certificate.
2. Click on "Create device certificate" to create a new device certificate.
3. **{Optional}** Click on "Export device PEM" to export the certificate in PEM format. This file needs to be uploaded to the device as will be explained in the subsequent sections.
4. **{Optional}** Click on "Display device certificate" to view the certificate in the standard Windows format.



Figure 21: Device key options

- **Device private key:** This is the private key corresponding to the public key in the device certificate and is also uniquely linked to a device ID. Click on "Export Device Private key" to export the key in PEM format. This file needs to be uploaded to the device as will be explained in the subsequent sections.
- **Export all files:** On creating all the files, click the "Export all files" button to save all the necessary files. After exporting all the necessary files, a new directory will be created in the same folder as the executable file with all the necessary configuration file and certificates.

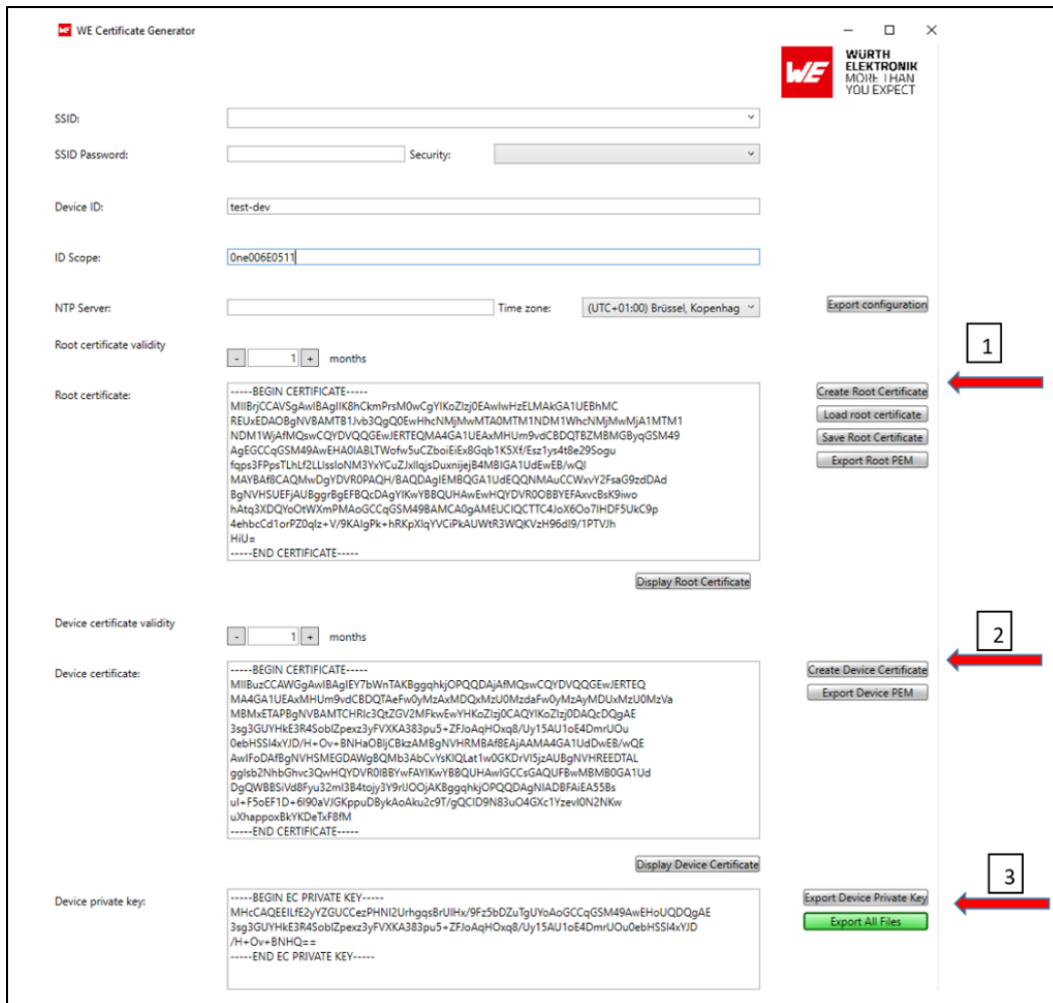

Figure 22: Certificate generation steps

(C:) > Projects > calypso_cert_generator > CalypsoCertificateUploader > bin > Debug > net6.0-windows > Azure > test-dev

Name	Änderungsdatum	Typ	Größe
device_root_cert	14.06.2023 20:05	Dateiordner	
azdevcert	14.06.2023 20:05	Datei	2 KB
azdevconf	14.06.2023 20:05	Datei	1 KB
azdevkey	14.06.2023 20:05	Datei	1 KB
azrootca	16.01.2023 11:19	Datei	2 KB
azrootca1	16.01.2023 11:19	Datei	2 KB

Figure 23: Files exported

3.4 Upload the Root certificate to IoT central

In this step, the device root certificate is uploaded and a policy is set to allow all devices with leaf certificates that are generated from this root, to be allowed to connect to the platform. If an organization does not exist, create an organization as described in <https://learn.microsoft.com/en-us/azure/iot-central/core/howto-create-organizations>.

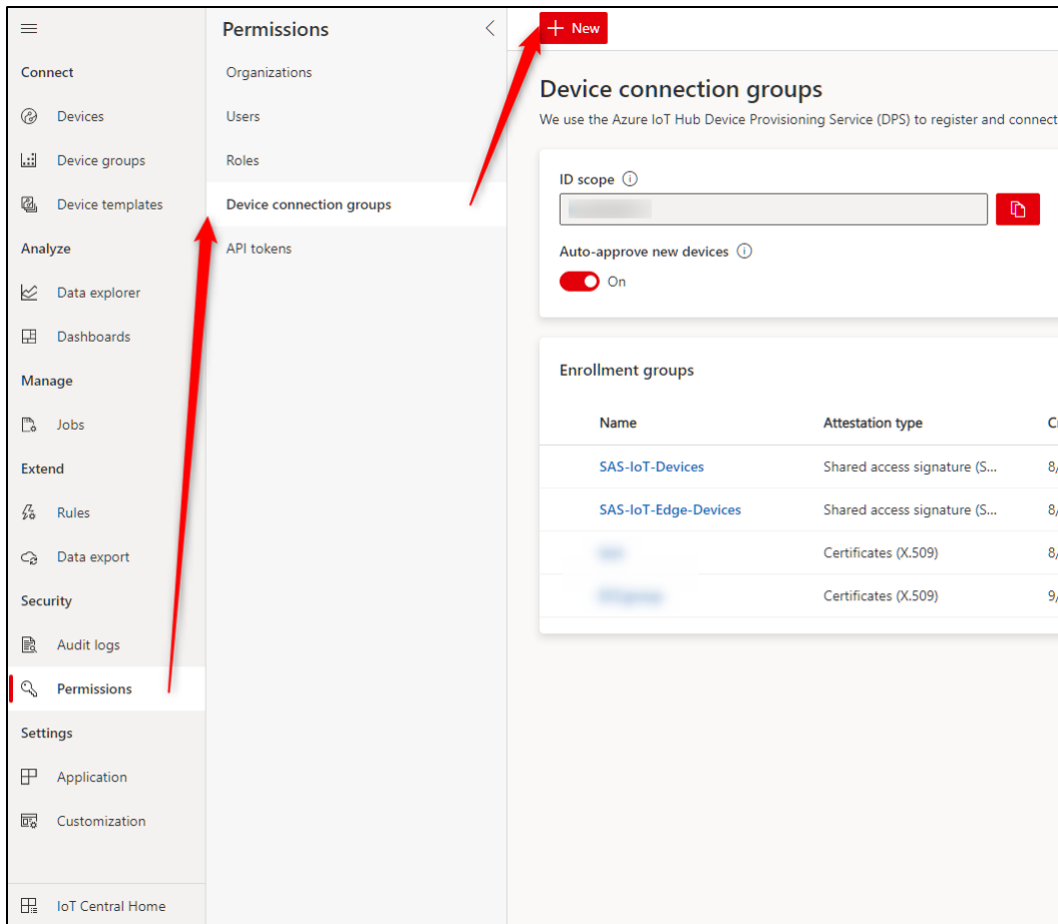
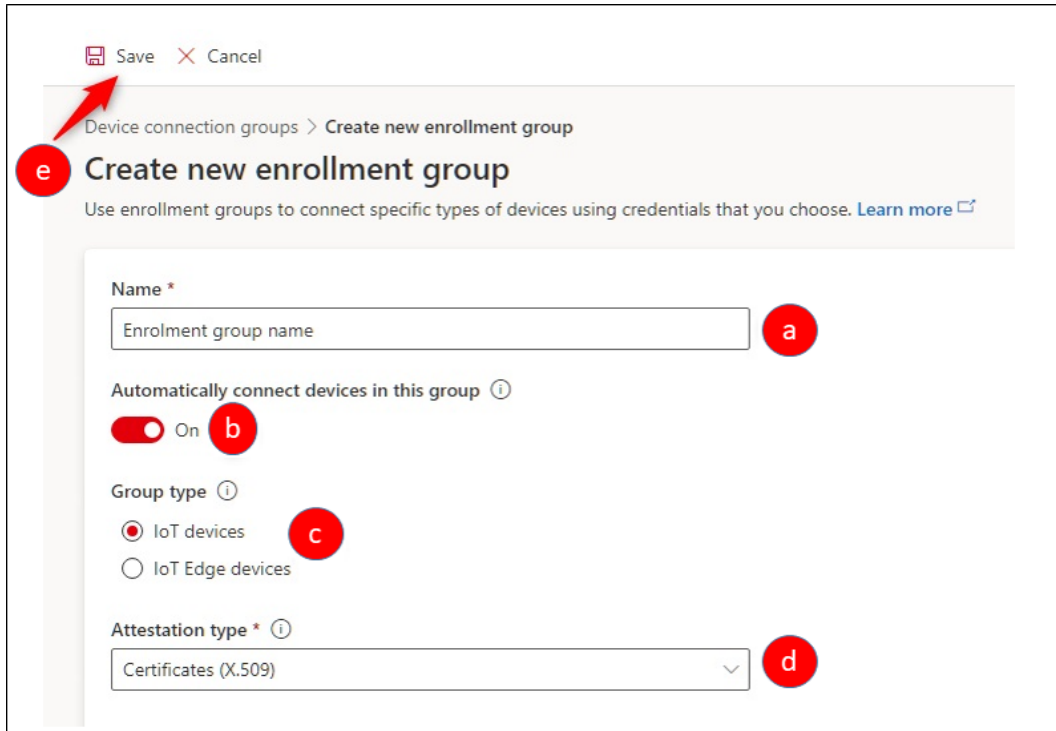

Figure 24: Create a new device enrolment group

- In the IoT central app open, "Permissions > Device connection groups" and click on "+ New"



Save Cancel

Device connection groups > Create new enrollment group

Create new enrollment group

Use enrollment groups to connect specific types of devices using credentials that you choose. [Learn more](#)

Name *

 a

Automatically connect devices in this group ⓘ

On b

Group type ⓘ

IoT devices c

IoT Edge devices

Attestation type * ⓘ

 d

Figure 25: Enrolment group options

- In the subsequent window,
 1. Enter a name for the enrolment group.
 2. Set the "Automatically connect devices in this group" to "On".
 3. Set the group type to "IoT devices"
 4. Set the attestation type to "Certificates (X.509)"
 5. Click on "Save".
- Once the enrolment group is created, the root certificate needs to be added to this group. In order to do this,

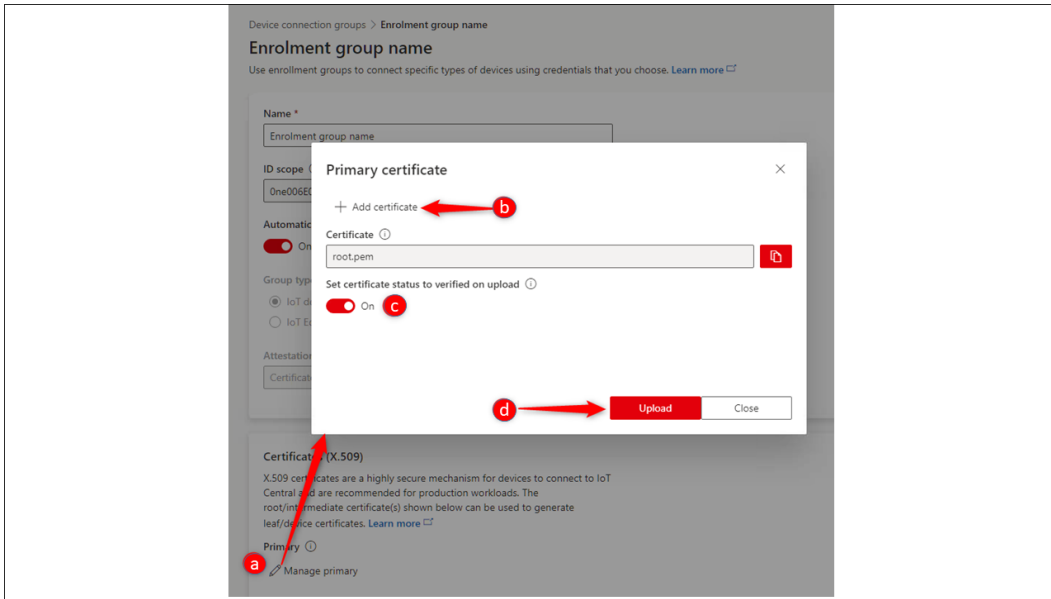

Figure 26: Upload device root certificate

1. Click on "Manage primary" in the "Certificates (X.509)" section of the enrolment group.
2. In the pop-up window, click on "Add certificate" and select the device root file generated using the WE certificate generator.
3. Set the "Set certificate status to verified on upload" option to "On".
4. Click on "Upload"
5. On completion of the upload process, close the pop-up window.

3.5 Configure the device

The design kit comes with the Firmware pre-installed. In this step, a one-time configuration of the kit is done which enables connection to the desired WiFi network and the previously create IoT central application.

- Ensure that all four boards are stacked up correctly with the Adafruit FeatherWing OLED on the top.
- Power up the design kit stack via USB or a Li-Po connector on the Adafruit M0 Feather board.

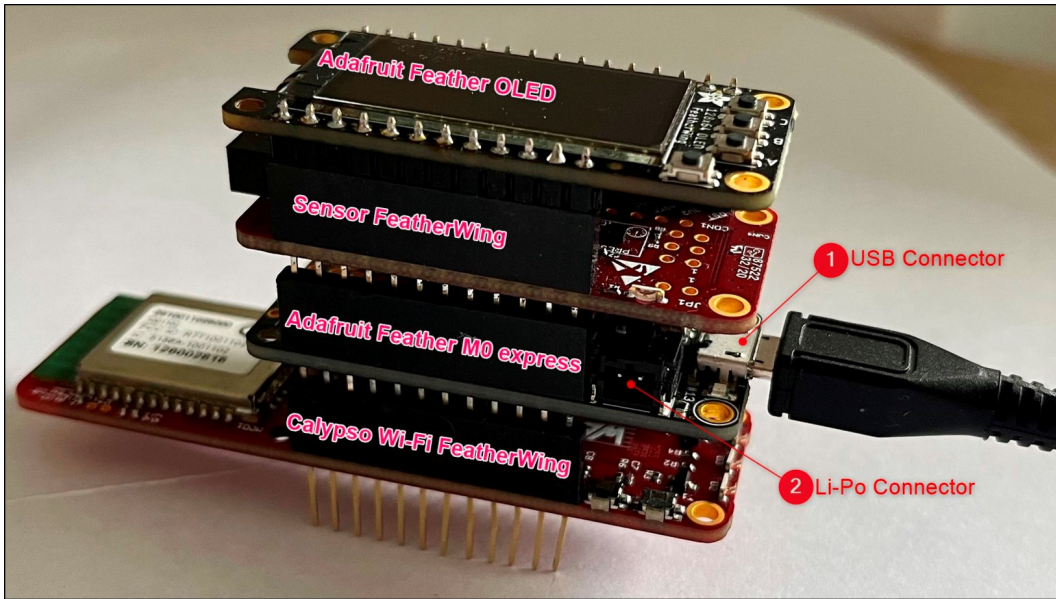

Figure 27: Power-up the design kit

- After a short initialization process, the device waits for the user to start the configuration process. The following message appears on the display "Device not configured. To configure double press button C".
- Double press button C on the OLED display FeatherWing to enter the configuration mode.

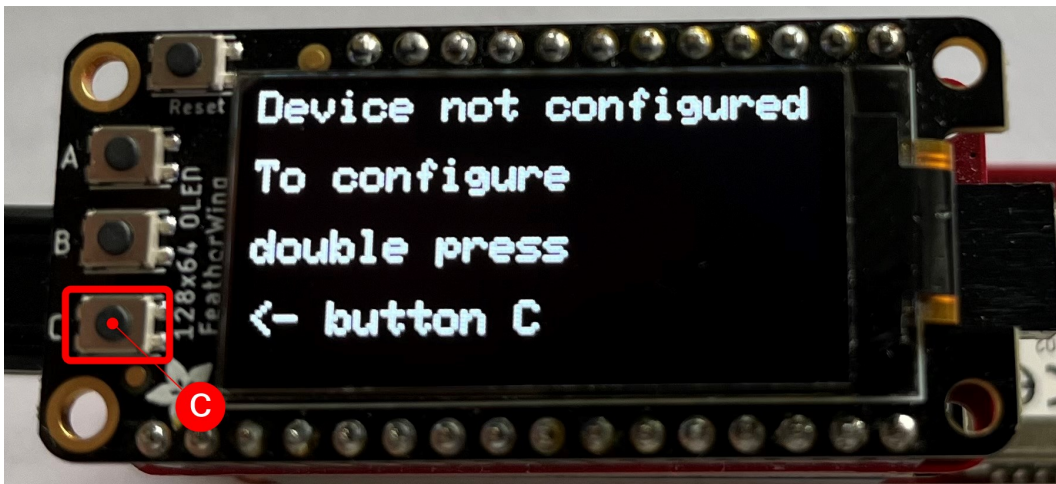

Figure 28: Double press on button C

- In the configuration mode, perform the following five steps,
 1. In the configuration mode, the Calypso WiFi module is set to access point mode with an SSID "calypso_<MAC_ADDRESS>" and the key "calypsowlan". Connect your PC (Laptop/tablet/smartphone) to this access point, displayed on the screen.

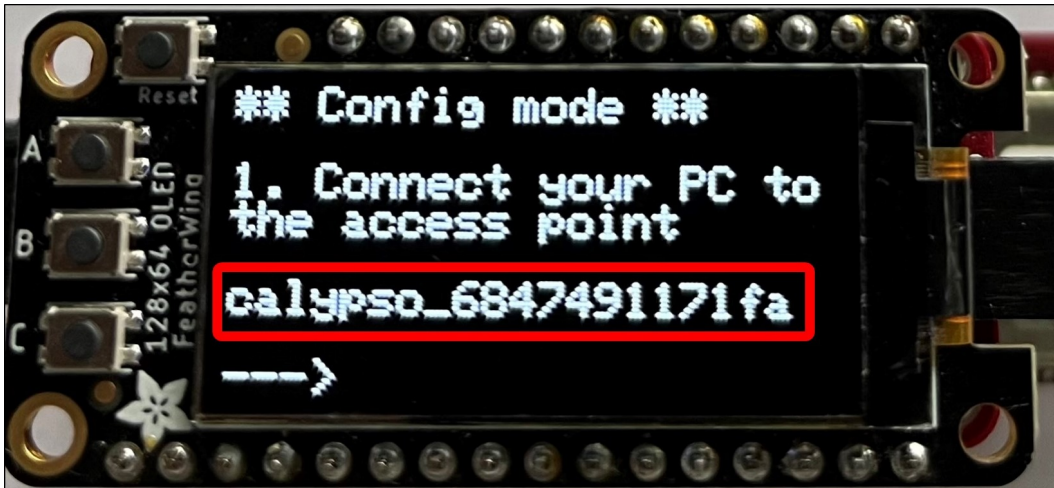

Figure 29: Device in access point mode



Figure 30: Connect to the device in access point mode

2. On the PC, open a browser.
3. In the browser, navigate to <http://calypso.net/azure.html>.

- Click on the "Choose Files" button. This opens the file browser. Browse to the location where the configuration files were generated as described in section 3.3. The files are stored under the path "working directory > Azure > <Device ID>". Select all the files in the directory and click on the "Upload" button. On success, the message "Success: 204 No content" at the bottom of the page indicates a successful configuration of the device.

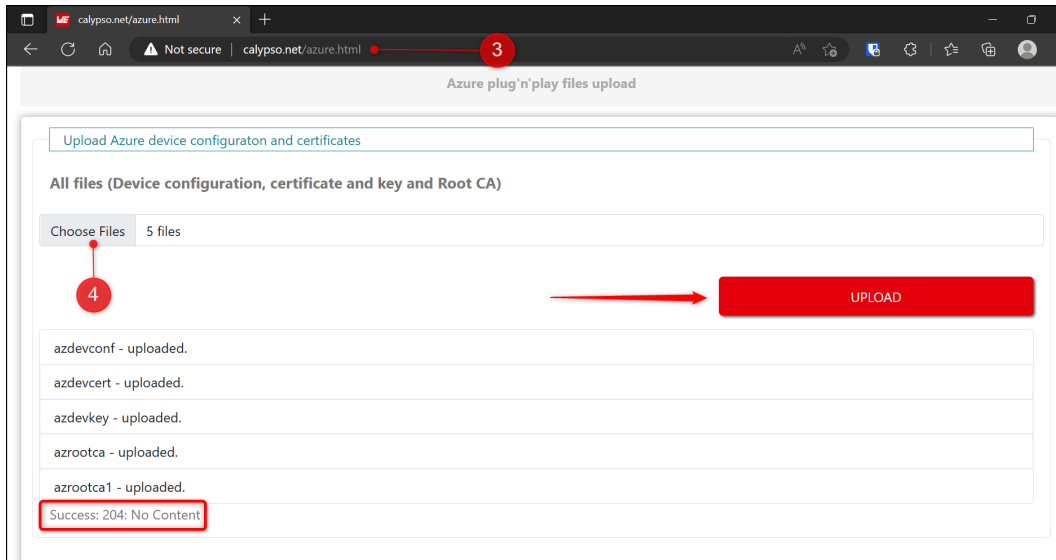

Figure 31: Select and upload files

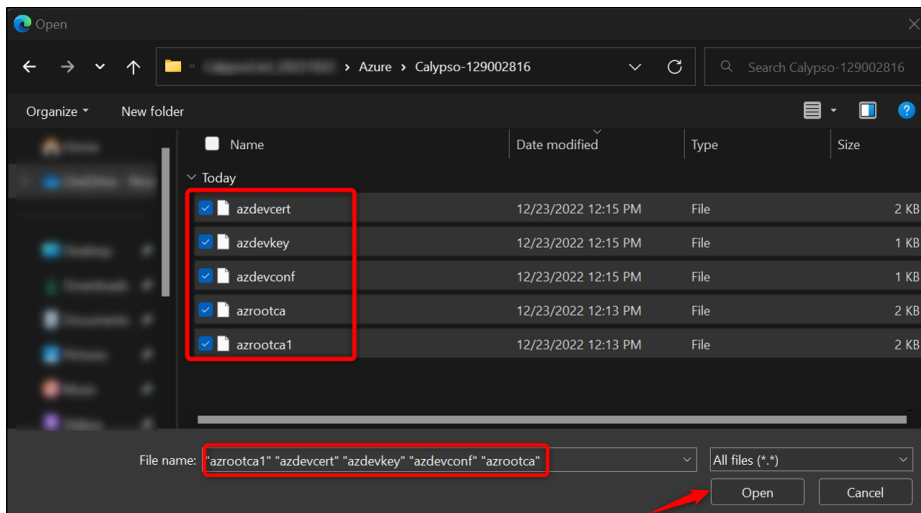

Figure 32: Select all the files generated by the PC tool

- Restart the device by clicking the "Reset" button.



Figure 33: Reset the device

- On restarting, the device goes through the following steps automatically,
 1. Initialize the hardware.
 2. Connect to the configured WiFi network.
 3. Connect to the Microsoft Azure Device Provisioning Service (DPS).
 4. After authentication, the DPS assigns the address of the IoT hub (Device management service of Azure) to connect.
 5. This address is saved in the secure storage of the Calypso WiFi module for further use.
 6. Finally, the device connects securely to the IoT central platform and starts the exchange of data.

At this stage, the device is fully configured, securely connected, and ready to use. On subsequent boot-up, the device directly connects to the platform using the saved address and starts exchanging data with the platform.



Figure 34: Device online

3.6 View the device default dashboard

To access the device on the IoT platform, navigate to "Devices -> All devices -> <Device ID>". Click on the device name to open the device page.

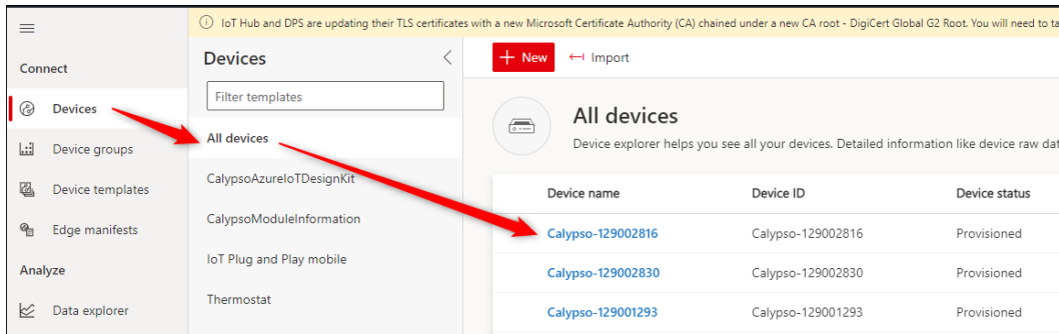

Figure 35: Device list on IoT central

In the "about" tab, the properties are displayed.

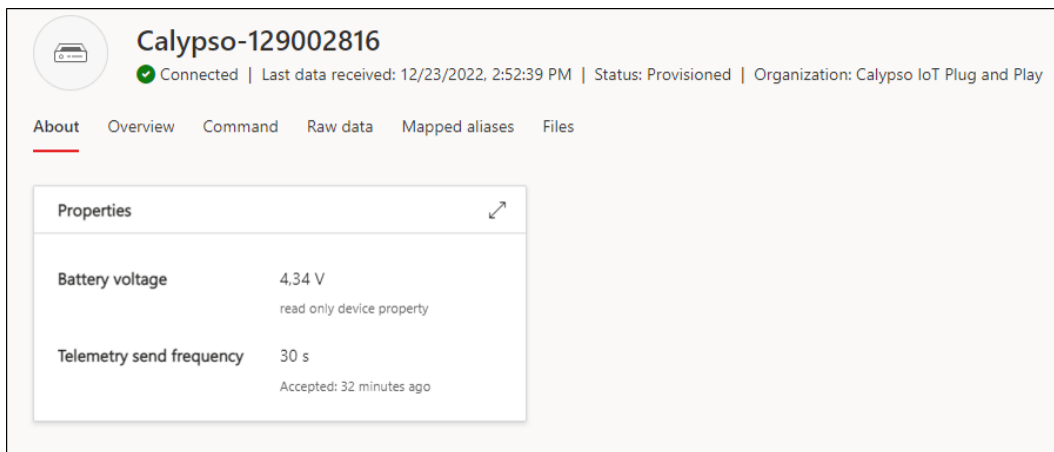

Figure 36: About the device

The telemetry data is displayed graphically in the "Overview" tab.

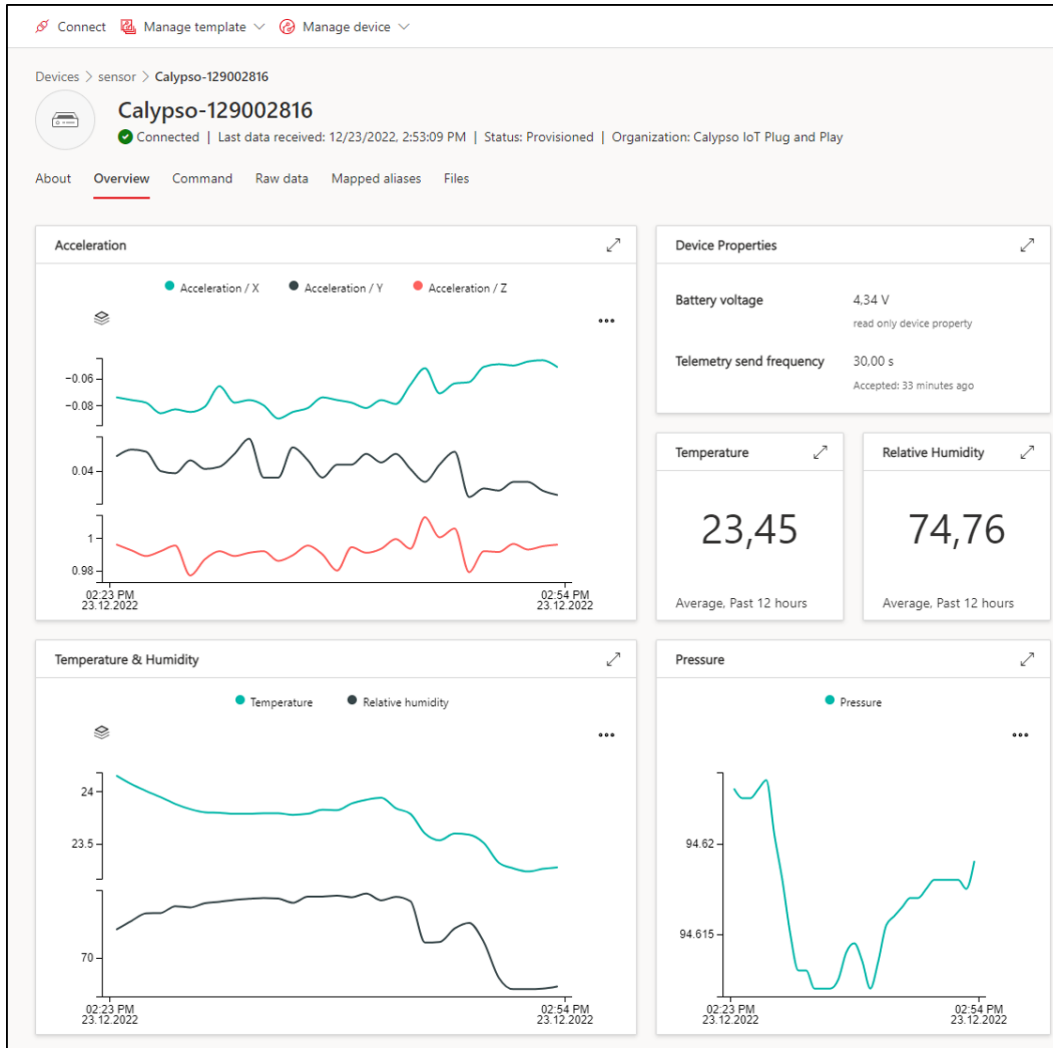

Figure 37: Overview of telemetry data

3.7 Send commands to device

To send a command to change the mini neo-pixel LED on the device, click on the command tab on the device page. Enter the RGB values and click on Run. The message is processed by the device and the colour of the LED is changed accordingly. A few sample colours,

Colour	R	G	B
Red	255	0	0
Green	0	255	0
Blue	0	0	255
Yellow	255	255	0
White	255	255	255
Cyan	0	255	255

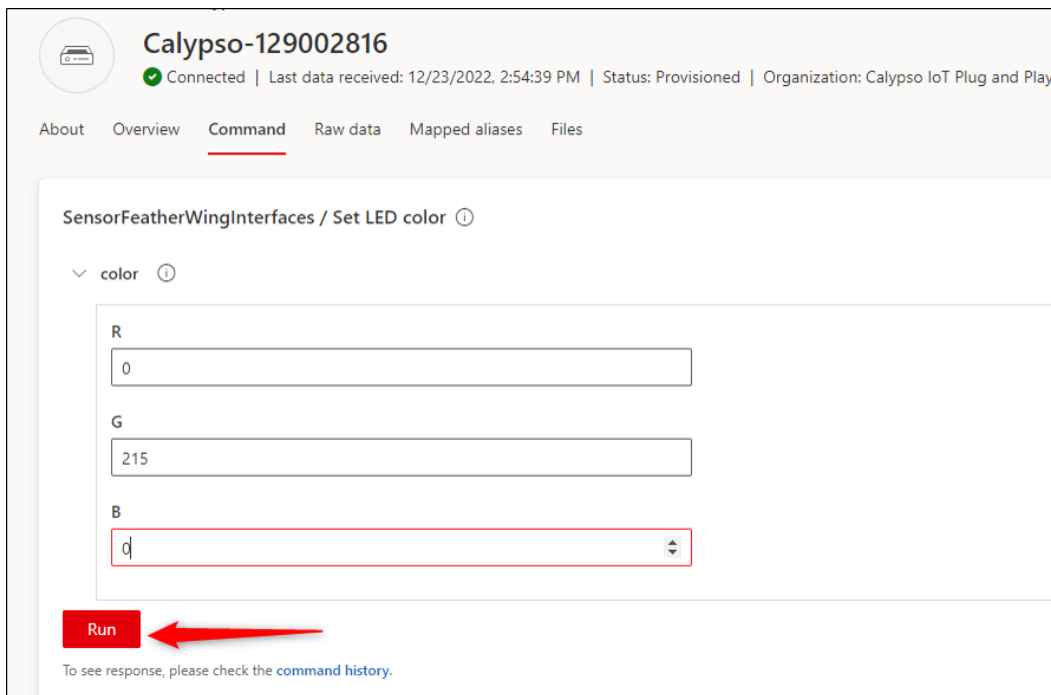

Figure 38: Set the LED using the command

3.8 Update device property

This device allows changing the frequency with which the sensor data is read and sent to the platform. This can be done from the IoT central platform. To do so, open click on the "Manage device" drop-down and select "Device properties". This opens the property update page.

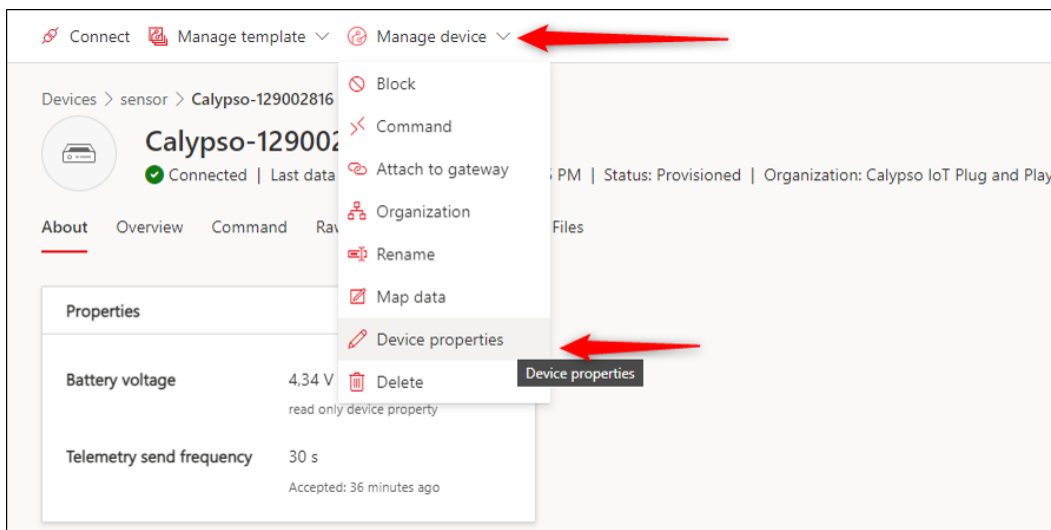

Figure 39: Set the send interval property

To update the send frequency, type in `"telemetrySendFrequency": <Send frequency in seconds>` and click on "Send to device". This update the device sends frequency on the device itself.



Figure 40: Set writable property

3.9 Factory reset

In order to reset the device to factory state, press the "button C" once, then Press and hold "button C" till the following message is displayed on the screen, "Reset device to factory state". This procedure resets the device to default state. Follow the device configuration process defined earlier to reconfigure the device.

4 Software description

Würth Elektronik eiSos provides a Software Development Kit (SDK) with examples to support all the FeatherWings created by Würth Elektronik eiSos. In this chapter, the salient features of the WE FeatherWing SDK are described.

- The SDK is open-source and well-documented.
- It uses a popular open-source toolchain including an IDE.
- The examples are written in Arduino-styled C/C++ for quick prototyping.
- The core components of the SDK are written in pure C to enable easy porting to any microcontroller platform.
- Development platform independent (Windows, Linux, or MAC).
- Modular structure of the software stack makes it easy to integrate into any project.

Specifically for this EV-Kit, the GitHub repository contains the software to interact with Microsoft IoT central as a plug-and-play device. This SDK provides a perfect software platform to build and test prototypes rapidly.

The SDK can be accessed on GitHub at github.com/WurthElektronik/Calypso-IoT-PnP-Design-Kit.

4.1 Software architecture

The Würth Elektronik eiSos FeatherWing SDK is built up in a modular way using a set of open-source tools to enable complete flexibility for the user.

The figure 41 shows the architecture of the Würth Elektronik eiSos FeatherWing SDK.

- **PlatformIO:** is a cross-platform, cross-architecture, multiple framework professional tool for embedded software development. It provides the toolchain necessary for software development including building, debugging, code-upload, and many more. PlatformIO works well on all modern operating systems and supports a host of development boards including the Feathers from Adafruit. Further details about PlatformIO can be found under platformio.org
- **Platform interface:** this layer provides an abstraction to the peripheral drivers for the platform being used. Currently, this SDK implements an abstraction to the Arduino peripheral drivers for the Feather M0 express platform.
- **Würth Elektronik eiSos SDK:** this is a layer of platform-independent pure C drivers for sensors and wireless connectivity modules from Würth Elektronik eiSos. These drivers implement all the necessary functions to utilize the full feature set of the sensors and wireless connectivity modules.
More details on the SDK and downloads under github.com/WurthElektronik. One SDK addresses Sensors and the second one the Wireless Connectivity modules.

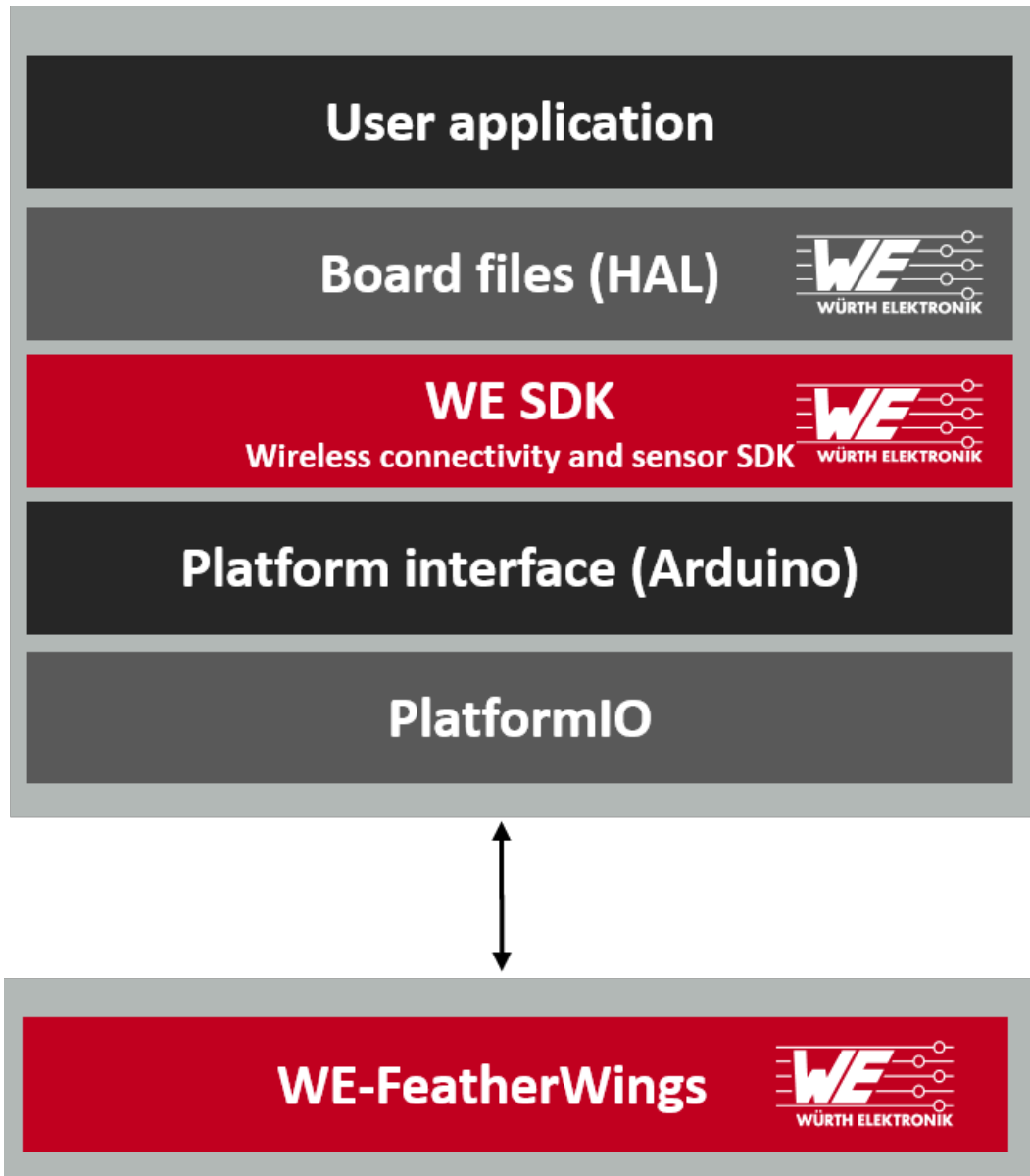

Figure 41: Software architecture

- **Board files:** this layer provides abstraction at a board level and provides functions to configure and control individual FeatherWings from Würth Elektronik eiSos.
- **User application:** The SDK currently implements an example to connect to the Microsoft IoT central platform.

5 Regulatory compliance information

Pursuant to Article 1 (2.) of the EU directive 2014/53/EU, Article 1 (2.) the directive does not apply to equipment listed in Annex I (4.): custom-built EV-Kits destined for professionals to be used solely at research and development facilities for such purposes.

5.1 Exemption clause

Relevant regulation requirements are subject to change. Würth Elektronik eiSos GmbH & Co. KG does not guarantee the accuracy of the before mentioned information. Directives, technical standards, procedural descriptions and the like may be interpreted differently by the national authorities. Equally, the national laws and restrictions may vary with the country. In case of doubt or uncertainty, we recommend that you consult with the authorities or official certification organizations of the relevant countries. Würth Elektronik eiSos GmbH & Co. KG is exempt from any responsibilities or liabilities related to regulatory compliance.

Notwithstanding the above, Würth Elektronik eiSos GmbH & Co. KG makes no representations and warranties of any kind related to their accuracy, correctness, completeness and/or usability for customer applications. No responsibility is assumed for inaccuracies or incompleteness.

6 Important notes

The following conditions apply to all goods within the wireless connectivity and sensors product range of Würth Elektronik eiSos GmbH & Co. KG:

General customer responsibility

Some goods within the product range of Würth Elektronik eiSos GmbH & Co. KG contain statements regarding general suitability for certain application areas. These statements about suitability are based on our knowledge and experience of typical requirements concerning the areas, serve as general guidance and cannot be estimated as binding statements about the suitability for a customer application. The responsibility for the applicability and use in a particular customer design is always solely within the authority of the customer. Due to this fact, it is up to the customer to evaluate, where appropriate to investigate and to decide whether the device with the specific product characteristics described in the product specification is valid and suitable for the respective customer application or not. Accordingly, the customer is cautioned to verify that the documentation is current before placing orders.

Customer responsibility related to specific, in particular safety-relevant applications

It has to be clearly pointed out that the possibility of a malfunction of electronic components or failure before the end of the usual lifetime cannot be completely eliminated in the current state of the art, even if the products are operated within the range of the specifications. The same statement is valid for all software source code and firmware parts contained in or used with or for products in the wireless connectivity and sensor product range of Würth Elektronik eiSos GmbH & Co. KG. In certain customer applications requiring a high level of safety and especially in customer applications in which the malfunction or failure of an electronic component could endanger human life or health, it must be ensured by most advanced technological aid of suitable design of the customer application that no injury or damage is caused to third parties in the event of malfunction or failure of an electronic component.

Best care and attention

Any product-specific data sheets, manuals, application notes, PCNs, warnings and cautions must be strictly observed in the most recent versions and matching to the products revisions. These documents can be downloaded from the product specific sections on the wireless connectivity and sensors homepage.

Customer support for product specifications

Some products within the product range may contain substances, which are subject to restrictions in certain jurisdictions in order to serve specific technical requirements. Necessary information is available on request. In this case, the Business Development Engineer (BDM) or the internal sales person in charge should be contacted who will be happy to support in this matter.

Product improvements

Due to constant product improvement, product specifications may change from time to time. As a standard reporting procedure of the Product Change Notification (PCN) according to the JEDEC-Standard, we inform about major changes. In case of further queries regarding the PCN, the Business Development Engineer (BDM), the internal sales person or the technical support team in charge should be contacted. The basic responsibility of the customer as per section 6 and 6 remains unaffected.

All software like "wireless connectivity SDK", "Sensor SDK" or other source codes as well as all PC software tools are not subject to the Product Change Notification information process.

Product life cycle

Due to technical progress and economical evaluation, we also reserve the right to discontinue production and delivery of products. As a standard reporting procedure of the Product Termination Notification (PTN) according to the JEDEC-Standard we will inform at an early stage about inevitable product discontinuance. According to this, we cannot ensure that all products within our product range will always be available. Therefore, it needs to be verified with the Business Development Engineer (BDM) or the internal sales person in charge about the current product availability expectancy before or when the product for application design-in disposal is considered. The approach named above does not apply in the case of individual agreements deviating from the foregoing for customer-specific products. The approach named above does not apply in the case of EV-Boards. EV-Boards may be changed without any notification.

Property rights

All the rights for contractual products produced by Würth Elektronik eiSos GmbH & Co. KG on the basis of ideas, development contracts as well as models or templates that are subject to copyright, patent or commercial protection supplied to the customer will remain with Würth Elektronik eiSos GmbH & Co. KG. Würth Elektronik eiSos GmbH & Co. KG does not warrant or represent that any license, either expressed or implied, is granted under any patent right, copyright, mask work right, or other intellectual property right relating to any combination, application, or process in which Würth Elektronik eiSos GmbH & Co. KG components or services are used.

General terms and conditions

Unless otherwise agreed in individual contracts, all orders are subject to the current version of the "General Terms and Conditions of Würth Elektronik eiSos Group", last version available at www.we-online.com.

7 Terms of Use for Würth Elektronik eiSos GmbH & Co. KG EV-Boards, evaluation kits and evaluation modules

Würth Elektronik eiSos GmbH & Co. KG provide you as a user with technical data (including data sheets), design resources (including reference designs), recommendations for use or other design recommendations, web tools, safety information and other information in the form of evaluation-boards, -kits or -modules (hereinafter jointly referred to as "EVB") in accordance with the terms and conditions contained here. The EVB is provided in the "as is" state. WE disclaims all express and implied warranties, in particular those concerning the suitability for a certain purpose, the absence of defects or non-violation of third-party rights. The EVB is intended for experienced developers to develop

their application with WE components. As a user, you are solely responsible for: (1) selection of the appropriate WE components for the application, (2) design, validation and testing the application, and (3) assurance that the application meets the applicable standards and all other safety requirements and other applicable requirements. WE may change the EVB without prior notice. WE grants you permission to use the EVB only for developing an application suitable for using WE components. Any other duplication, representation or transfer of the EVB is expressly prohibited. WE does not grant any licenses for the use of the intellectual property rights from WE or third parties. WE is fully indemnified from all claims, damages, costs, losses and liabilities arising from the misuse of this EVB. The WE components are provided in accordance with WE's conditions of sale or other applicable conditions available either at <https://katalog.we-online.com> or in conjunction with such WE components. WE's provision of the EVB does not constitute an extended warranty in relation to the WE components.

General warnings

Do not touch the EVB when it is live, and allow charged components, such as capacitors, to discharge completely before handling the EVB. Depending on the individual application, high voltages can occur on the EVB and some components can reach temperatures above 50 °C. Even after disconnecting the EVB from the power source, these conditions remain for a significant time. Please ensure that the appropriate safety precautions are taken when installing and operating this EVB, as one of the following may occur if you handle or use this EVB without observing the relevant safety precautions: - Death - Serious injury - Electric shock - Electric burns - Severe heat burns -

When using the EVB, you undertake to read the instructions for use in full together with the relevant information supplied and/or available on the homepage www.we-online.de/wcs-manuals before putting this EVB into operation. The following points have to be observed in particular:

- Do not touch the EVB while it is live.
- The EVB must be fully assembled and all devices to be tested must be connected before voltage is applied to the EVB.
- The EVB should never be left unattended during operation.
- Capacitors must be completely discharged. The capacitors must be actively discharged using a suitable resistor.

Protection against static electricity

Use the unpackaged product only in ESD protected areas. Wear the ESD personal protective equipment prescribed for these areas. Ground all conductive components, including personnel, as prescribed in ESD protected areas. Ensure that the product is only used by trained personnel.

Purpose and use

The EVB is not a finished product and is not intended for general use by the consumer. The EVB is intended exclusively for use in the evaluation of WE components in the lab or in development environments by highly qualified technicians or engineers, familiar with the risks involved in handling electrical or mechanical components, systems and subsystems. The use of the EVB is your full and independent responsibility. The EVB is expressly not intended to be installed in a terminal device or to be part of a terminal device in whole or in part. WE reserves the right, at its own discretion, to make corrections, improvements, adjustments or other changes to the EVB or to discontinue the EVB. The EVB is not intended for use in devices and applications for which a higher safety and reliability standard is prescribed. It is also not approved for use in safety-relevant applications or where personal injury or fatal consequences must be expected in the event of failure.

Operation of the EVB

The EVB may only be operated within the specifications and environmental parameters recommended by WE, as described in the instructions for use. Exceeding the specified parameters (including, but not limited to, input and output voltage, current, power, and ambient conditions) may result in damage to property. If you have questions about these electrical parameters, please contact WE at (regulatory-compliance@we-online.com) prior to connecting peripheral electronics (including the input voltage and intended loads). Any load outside a certain power range may lead to negative consequences, including, but not limited to, unintended or inaccurate evaluations or possibly permanent damage to the EVB or the electronics connected to it. Please ensure that the appropriate safety precautions are taken when working with the EVB, as serious injuries, including severe or even fatal injuries from electric shock or electric burns, may occur if you do not follow the appropriate safety precautions. Under no circumstances should the EVB be touched while live. When the EVB is connected to a power source, some of its components are electrically charged and/or have temperatures above 50 °C. This condition also applies for a short time after disconnecting from the supply voltage until the capacitors are completely discharged and hot components have cooled down. These components include connectors, linear regulators, switching transistors, heat sinks, resistors, diodes, inductors and other components, which can be identified from the documentation in the instructions for use. As with all electronic lab work, only qualified persons with knowledge of electronic performance evaluation, measurement and diagnostic tools, should use the EVB.

Hazards and warnings

Before putting the EVB into operation, please read the instructions for use and especially the various hazards and warnings described therein. The instructions for use contain important safety information on voltages and temperatures. You take full responsibility and liability for the proper and safe handling of the EVB. You agree to comply with all safety requirements, rules and regulations related to the use of the EVB. You also take full responsibility for: (1) establishing safeguards to ensure that the use of the EVB does not cause damage to property, personal injury or death, even if the EVB does not function as described, intended or expected, (2) the test setup in which the EVB is integrated, all safety requirements, rules and regulations and also that no damage to property, personal injury or other hazardous situation occurs even if the EVB fails, and (3) ensuring the safety of all activities performed by you or your employees when using the EVB. In particular, this means that the technical rules VDE [German Electrical Engineering, Electronic and Information Technology Association] 0105-100 and BGI [German trade association information] 891 (or corresponding applicable safety regulations outside Germany) for the operation of electrical test setups must be observed, the test area is protected against unauthorized access or accidental touching, current limitations, and emergency stop mechanisms are functional and test setups are never operated unattended. If you have any questions about the safe use of the EVB, please contact WE at regulatory-compliance@we-online.com for more information.

Your responsibility with regard to the applicable laws

- You are responsible for being sufficiently informed about and complying with all international, national, state and local applicable laws, rules and regulations that apply to the handling or use of the EVB by you or your employees.
- The EVB generates, uses and radiates radio frequency energy, but has not been tested for conformity with the limits applicable to the product category, which are applicable according to the European Union regulations for protection against radio frequency interference. Operation of the EVB may cause interference with radio communication. In this case, the costs incurred for necessary measures to remedy the interference are to be borne by the user.

As the EVB is not a finished product, it may not comply with applicable regulatory, safety or certification standards that are normally as-

sociated with other products, such as Directive 2011/65/EC of the European Parliament and of the Council of 8 June 2011 on the restriction of the use of hazardous substances and Directive 2002/96/EC on waste electrical and electronic equipment (WEEE). You take full responsibility for compliance with such standards that apply to the EVB. You also take responsibility for the proper disposal of the components and materials of the EVB.

Exclusion of further rights and rights of use for intellectual property of EVB

The sale of an EVB does not constitute the granting by WE of any license or other right of any kind - expressly or implicitly - including, but not limited to, any patent, copyright, trademark or other proprietary rights. All rights from such patent, copyright, trademark or other proprietary rights are expressly reserved by WE. The EVB must not be used in any manner that directly or indirectly infringes any patent, copyright, trademark or other proprietary rights of WE.

Warranty of EVB

WE ensures that the EVB meets the specifications given in the instructions for use (within the deviations stated therein) for a period of 12 months from the date of purchase and functions in accordance with the instructions for use. On the basis of the underlying statutory provisions, WE shall rectify defects or offer free replacement of the EVB to which damage occurs that is evidently attributable to a defect for which WE is responsible and is at fault. A warranty claim is subject to the user having complied with the statutory duties of inspection and notification of defects and that the EVB has been received by WE no later than ten (10) days after expiry of the warranty period. This warranty is not transferable to others. This warranty does not apply to defects or impairments in performance resulting from incorrect use, use contrary to WE's instructions, improper installation, improper operation or misuse. WE accepts no liability whatsoever for the failure of equipment or other items not manufactured by or for WE, including, but not limited to, equipment or items to which the EVB is attached or for which the EVB is used. WE DOES NOT GRANT ANY WARRANTIES OR ASSURANCES WHATSOEVER, EXPRESS OR IMPLIED, WITH RESPECT TO THE EVB, INCLUDING, BUT NOT LIMITED TO, ANY IMPLIED WARRANTIES OF MARKETABILITY OR SUITABILITY FOR A PARTICULAR PURPOSE.

Limitation of liability for EVB

WE'S OVERALL LIABILITY FOR DAMAGE CAUSED BY WE IS LIMITED TO DAMAGE THAT TYPICALLY OCCURS. WE DOES NOT ACCEPT ANY LIABILITY FOR LOSS OF PROFIT, CONSEQUENTIAL OR SPECIAL LOSSES, OR SPECIAL, INDIRECT, INCIDENTAL AND CONSEQUENTIAL DAMAGE. HOWEVER, THIS LIMITATION OF LIABILITY DOES NOT APPLY IN THE CASE OF INTENTIONAL OR GROSSLY NEGLIGENT ACTS AND FOR THE DAMAGE RESULTING FROM LOSS OF LIFE, PHYSICAL INJURY, HARM TO HEALTH OR IN CASE OF LEGAL MANDATORY LIABILITY [AS IN GERMAN PRODUCT LIABILITY LAW, ProdHaftG].

8 Legal notice

Exclusion of liability

Würth Elektronik eiSos GmbH & Co. KG considers the information in this document to be correct at the time of publication. However, Würth Elektronik eiSos GmbH & Co. KG reserves the right to modify the information such as technical specifications or functions of its products or discontinue the production of these products or the support of one of these products without any written announcement or notification to customers. The customer must make sure that the information used corresponds to the latest published information. Würth Elektronik eiSos GmbH & Co. KG does not assume any liability for the use of its products. Würth Elektronik eiSos GmbH & Co. KG does not grant licenses for its patent rights or for any other of its intellectual property rights or third-party rights.

Notwithstanding anything above, Würth Elektronik eiSos GmbH & Co. KG makes no representations and/or warranties of any kind for the provided information related to their accuracy, correctness, completeness, usage of the products and/or usability for customer applications. Information published by Würth Elektronik eiSos GmbH & Co. KG regarding third-party products or services does not constitute a license to use such products or services or a warranty or endorsement thereof.

Suitability in customer applications

The customer bears the responsibility for compliance of systems or units, in which Würth Elektronik eiSos GmbH & Co. KG products are integrated, with applicable legal regulations. Customer acknowledges and agrees that it is solely responsible for compliance with all legal, regulatory and safety-related requirements concerning its products, and any use of Würth Elektronik eiSos GmbH & Co. KG components in its applications, notwithstanding any applications-related information or support that may be provided by Würth Elektronik eiSos GmbH & Co. KG. Customer represents and agrees that it has all the necessary expertise to create and implement safeguards which anticipate dangerous consequences of failures, monitor failures and their consequences lessen the likelihood of failures that might cause harm and take appropriate remedial actions. The customer will fully indemnify Würth Elektronik eiSos GmbH & Co. KG and its representatives against any damages arising out of the use of any Würth Elektronik eiSos GmbH & Co. KG components in safety-critical applications.

Trademarks

AMBER wireless is a registered trademark of Würth Elektronik eiSos GmbH & Co. KG. All other trademarks, registered trademarks, and product names are the exclusive property of the respective owners.

Usage restriction

Würth Elektronik eiSos GmbH & Co. KG products have been designed and developed for usage in general electronic equipment only. This product is not authorized for use in equipment where a higher safety standard and reliability standard is especially required or where a failure of the product is reasonably expected to cause severe personal injury or death, unless the parties have executed an agreement specifically governing such use. Moreover, Würth Elektronik eiSos GmbH & Co. KG products are neither designed nor intended for use in areas such as military, aerospace, aviation, nuclear control, submarine, transportation (automotive control, train control, ship control), transportation signal, disaster prevention, medical, public information network etc. Würth Elektronik eiSos GmbH & Co. KG must be informed about the intent of such usage before the design-in stage. In addition, sufficient reliability evaluation checks for safety must be performed on every electronic component, which is used in electrical circuits that require high safety and reliability function or performance. By using Würth Elektronik eiSos GmbH & Co. KG products, the customer agrees to these terms and conditions.

9 License terms

These License terms will take effect upon the purchase and usage of the Würth Elektronik eiSos GmbH & Co. KG wireless connectivity products. You hereby agree that these license terms are applicable to the product and the incorporated software, firmware and source codes (collectively, "Software") made available by Würth Elektronik eiSos in any form, including but not limited to binary, executable or source code form. The software included in any Würth Elektronik eiSos wireless connectivity product is purchased to you on the condition that you accept the terms and conditions of these license terms. You agree to comply with all provisions under these license terms.

Limited license

Würth Elektronik eiSos hereby grants you a limited, non-exclusive, non-transferable and royalty-free license to use the software and under the conditions that will be set forth in these license terms. You are free to use the provided software only in connection with one of the products from Würth Elektronik eiSos to the extent described in these license terms. You are entitled to change or alter the source code for the sole purpose of creating an application embedding the Würth Elektronik eiSos wireless connectivity product. The transfer of the source code to third parties is allowed to the sole extent that the source code is used by such third parties in connection with our product or another hardware provided by Würth Elektronik eiSos under strict adherence of these license terms. Würth Elektronik eiSos will not assume any liability for the usage of the incorporated software and the source code. You are not entitled to transfer the source code in any form to third parties without prior written consent of Würth Elektronik eiSos.

You are not allowed to reproduce, translate, reverse engineer, decompile, disassemble or create derivative works of the incorporated software and the source code in whole or in part. No more extensive rights to use and exploit the products are granted to you.

Usage and obligations

The responsibility for the applicability and use of the Würth Elektronik eiSos wireless connectivity product with the incorporated firmware in a particular customer design is always solely within the authority of the customer. Due to this fact, it is up to you to evaluate and investigate, where appropriate, and to decide whether the device with the specific product characteristics described in the product specification is valid and suitable for your respective application or not.

You are responsible for using the Würth Elektronik eiSos wireless connectivity product with the incorporated firmware in compliance with all applicable product liability and product safety laws. You acknowledge to minimize the risk of loss and harm to individuals and bear the risk for failure leading to personal injury or death due to your usage of the product.

Würth Elektronik eiSos' products with the incorporated firmware are not authorized for use in safety-critical applications, or where a failure of the product is reasonably expected to cause severe personal injury or death. Moreover, Würth Elektronik eiSos' products with the incorporated firmware are neither designed nor intended for use in areas such as military, aerospace, aviation, nuclear control, submarine, transportation (automotive control, train control, ship control), transportation signal, disaster prevention, medical, public information network etc. You shall inform Würth Elektronik eiSos about the intent of such usage before design-in stage. In certain customer applications requiring a very high level of safety and in which the malfunction or failure of an electronic component could endanger human life or health, you must ensure to have all necessary expertise in the safety and regulatory ramifications of your applications. You acknowledge and agree that you are solely responsible for all legal, regulatory and safety-related requirements concerning your products and any use of Würth Elektronik eiSos' products with the incorporated firmware in such safety-critical applications, notwithstanding any applications-related information or support that may be provided by Würth Elektronik eiSos. **YOU SHALL INDEMNIFY WÜRTH ELEKTRONIK EISOS AGAINST ANY DAMAGES ARISING OUT OF THE USE OF WÜRTH ELEKTRONIK EISOS' PRODUCTS WITH THE INCORPORATED FIRMWARE IN SUCH SAFETY-CRITICAL APPLICATIONS.**

Ownership

The incorporated firmware created by Würth Elektronik eiSos is and will remain the exclusive property of Würth Elektronik eiSos.

Firmware update(s)

You have the opportunity to request the current and actual firmware for a bought wireless connectivity product within the time of warranty. However, Würth Elektronik eiSos has no obligation to update a modules firmware in their production facilities, but can offer this as a service on request. The upload of firmware updates falls within your responsibility, e.g. via ACC or another software for firmware updates. Firmware updates will not be communicated automatically. It is within your responsibility to check the current version of a firmware in the latest version of the product manual on our website. The revision table in the product manual provides all necessary information about firmware updates. There is no right to be provided with binary files, so called "firmware images", those could be flashed through JTAG, SWD, Spi-Bi-Wire, SPI or similar interfaces.

Disclaimer of warranty

THE FIRMWARE IS PROVIDED "AS IS". YOU ACKNOWLEDGE THAT WÜRTH ELEKTRONIK EISOS MAKES NO REPRESENTATIONS AND WARRANTIES OF ANY KIND RELATED TO, BUT NOT LIMITED TO THE NON-INFRINGEMENT OF THIRD PARTIES' INTELLECTUAL PROPERTY RIGHTS OR THE MERCHANTABILITY OR FITNESS FOR YOUR INTENDED PURPOSE OR USAGE. WÜRTH ELEKTRONIK EISOS DOES NOT WARRANT OR REPRESENT THAT ANY LICENSE, EITHER EXPRESS OR IMPLIED, IS GRANTED UNDER ANY PATENT RIGHT, COPYRIGHT, MASK WORK RIGHT, OR OTHER INTELLECTUAL PROPERTY RIGHT RELATING TO ANY COMBINATION, MACHINE, OR PROCESS IN WHICH THE WÜRTH ELEKTRONIK EISOS' PRODUCT WITH THE INCORPORATED FIRMWARE IS USED. INFORMATION PUBLISHED BY WÜRTH ELEKTRONIK EISOS REGARDING THIRD-PARTY PRODUCTS OR SERVICES DOES NOT CONSTITUTE A LICENSE FROM WÜRTH ELEKTRONIK EISOS TO USE SUCH PRODUCTS OR SERVICES OR A WARRANTY OR ENDORSEMENT THEREOF.

Limitation of liability

Any liability not expressly provided by Würth Elektronik eiSos shall be disclaimed.

You agree to hold us harmless from any third-party claims related to your usage of the Würth Elektronik eiSos' products with the incorporated firmware, software and source code. Würth Elektronik eiSos disclaims any liability for any alteration, development created by you or your customers as well as for any combination with other products.

Applicable law and jurisdiction

Applicable law to these license terms shall be the laws of the Federal Republic of Germany. Any dispute, claim or controversy arising out of or relating to these license terms shall be resolved and finally settled by the court competent for the location of Würth Elektronik eiSos registered

office.

Severability clause

If a provision of these license terms is or becomes invalid, unenforceable or null and void, this shall not affect the remaining provisions of the terms. The parties shall replace any such provisions with new valid provisions that most closely approximate the purpose of the terms.

Miscellaneous

Würth Elektronik eiSos reserves the right at any time to change these terms at its own discretion. It is your responsibility to check at Würth Elektronik eiSos homepage for any updates. Your continued usage of the products will be deemed as the acceptance of the change.

We recommend you to be updated about the status of new firmware and software, which is available on our website or in our data sheet and manual, and to implement new software in your device where appropriate.

By ordering a product, you accept these license terms in all terms.

List of Figures

1	Calypso IoT design kit	4
2	Block diagram - Calypso IoT design kit	5
3	IoT application stack	7
4	Components of a data platform	8
5	System architecture	9
6	System design	10
7	The WE Sensor FeatherWing (2501000201291)	11
8	The WE Calypso FeatherWing (2610039025001)	11
9	The Adafruit Feather M0 express	12
10	Adafruit FeatherWing OLED	13
11	Architecture of IoT central platform.	14
12	The design kit	15
13	IoT central application	16
14	IoT central application parameters	17
15	IoT central application URL	18
16	IoT central application homepage	18
17	ID scope for the created IoT central application	19
18	Parameters to configure the device	20
19	Device root certificate options	20
20	Device certificate options	21
21	Device key options	21
22	Certificate generation steps	22
23	Files exported	23
24	Create a new device enrolment group	23
25	Enrolment group options	24
26	Upload device root certificate	25
27	Power-up the design kit	26
28	Double press on button C	26
29	Device in access point mode	27
30	Connect to the device in access point mode	27
31	Select and upload files	28
32	Select all the files generated by the PC tool	28
33	Reset the device	29
34	Device online	29
35	Device list on IoT central	30
36	About the device	30
37	Overview of telemetry data	31
38	Set the LED using the command	32
39	Set the send interval property	32
40	Set writable property	33
41	Software architecture	35

List of Tables

1	Contents of the design kit (2610059035001)	5
---	--	---



Contact

Würth Elektronik eiSos GmbH & Co. KG
Division Wireless Connectivity & Sensors

Max-Eyth-Straße 1
74638 Waldenburg
Germany

Tel.: +49 651 99355-0
Fax.: +49 651 99355-69
www.we-online.com/wireless-connectivity

WÜRTH ELEKTRONIK MORE THAN YOU EXPECT